

hp 12c financial calculator

user's guide



i n v e n t

Edition 4

HP Part Number 0012C-90001

Notice

REGISTER YOUR PRODUCT AT: www.register.hp.com

THIS MANUAL AND ANY EXAMPLES CONTAINED HEREIN ARE PROVIDED "AS IS" AND ARE SUBJECT TO CHANGE WITHOUT NOTICE. HEWLETT-PACKARD COMPANY MAKES NO WARRANTY OF ANY KIND WITH REGARD TO THIS MANUAL, INCLUDING, BUT NOT LIMITED TO, THE IMPLIED WARRANTIES OF MERCHANTABILITY, NON-INFRINGEMENT AND FITNESS FOR A PARTICULAR PURPOSE.

HEWLETT-PACKARD CO. SHALL NOT BE LIABLE FOR ANY ERRORS OR FOR INCIDENTAL OR CONSEQUENTIAL DAMAGES IN CONNECTION WITH THE FURNISHING, PERFORMANCE, OR USE OF THIS MANUAL OR THE EXAMPLES CONTAINED HEREIN.

© Copyright 1981, 2004 Hewlett-Packard Development Company, L.P. Reproduction, adaptation, or translation of this manual is prohibited without prior written permission of Hewlett-Packard Company, except as allowed under the copyright laws.

Hewlett-Packard Company
4995 Murphy Canyon Rd,
Suite 301
San Diego, CA 92123

Printing History

Edition 4

August 2004

Introduction

About This Handbook

This *hp 12c user's guide* is intended to help you get the most out of your investment in your hp 12c Programmable Financial Calculator. Although the excitement of acquiring this powerful financial tool may prompt you to set this handbook aside and immediately begin "pressing buttons," in the long run you'll profit by reading through this handbook and working through the examples it contains.

Following this introduction is a brief section called Making Financial Calculations Easy—which shows you that your hp 12c does just that! The remainder of this handbook is organized basically into three parts:

- Part I (sections 1 through 7) describes how to use the various financial, mathematics, statistics, and other functions (except for programming) provided in the calculator:
 - Section 1 is about Getting Started. It tells you how to use the keyboard, how to do simple arithmetic calculations and chain calculations, and how to use the storage registers ("memories").
 - Section 2 tells you how to use the percentage and calendar functions.
 - Section 3 tells you how to use the simple interest, compound interest, and amortization functions.
 - Section 4 tells you how to do discounted cash flow analysis, bond, and depreciation calculations.
 - Section 5 tells you about miscellaneous operating features such as Continuous Memory, the display, and special function keys.
 - Sections 6 and 7 tell you how to use the statistics, mathematics, and number-alteration functions.
- Part II (sections 8 through 11) describe how to use the powerful programming capabilities of the hp 12c.
- Part III (sections 12 through 16) give you step-by-step solutions to specialized problems in real estate, lending, savings, investment analysis, and bonds. Some of these solutions can be done manually, while others involve running a program. Since the programmed solutions are both self-contained and step-by-step, you can easily employ them even if you don't care to learn how to create your own programs. But if you *do* start to create your own programs, look over the programs used in the solutions: they contain examples of good programming techniques and practices.

4 Introduction

- The various appendices describe additional details of calculator operation as well as warranty and service information.
- The Function Key Index and Programming Key Index at the back of the handbook can be used as a handy page reference to the comprehensive information inside the manual

Financial Calculations in the United Kingdom

The calculations for most financial problems in the United Kingdom are identical to the calculations for those problems in the United States — which are described in this handbook. Certain problems, however, require different calculation methods in the United Kingdom than in the United States. Refer to Appendix F for more information.

For More Solutions to Financial Problems

In addition to the specialized solutions found in Sections 12 through 16 of this handbook, many more are available in the optional *hp 12c Solutions Handbook*. Included are solutions to problems in lending, forecasting, pricing, statistics, savings, investment analysis, personal finance, securities, Canadian mortgages, learning curves in manufacturing, and queuing theory. A Solutions Handbook is available online (www.hp.com/calculators).

Contents

Introduction.....	3
About This Handbook.....	3
Financial Calculations in the United Kingdom.....	4
For More Solutions to Financial Problems.....	4
Part I. Problem Solving	15
Section 1: Getting Started.....	16
Power On and Off.....	16
Low-Power Indication.....	16
The Keyboard	16
Keying in Numbers	17
Digit Separators	17
Negative Numbers	17
Keying in Large Numbers	18
The CLEAR Keys	18
Simple Arithmetic Calculations	19
Chain Calculations	20
Storage Registers.....	23
Storing and Recalling Numbers	23
Clearing Storage Registers	24
Storage Register Arithmetic	24
Section 2: Percentage and Calendar Functions.....	26
Percentage Functions.....	26
Percentages	26
Net Amount	27
Percent Difference	27
Percent of Total.....	28
Calendar Functions.....	29
Date Format	29
Future or Past Dates.....	30
Number of Days Between Dates	31
Section 3: Basic Financial Functions	32
The Financial Registers	32
Storing Numbers Into the Financial Registers	32
Displaying Numbers in the Financial Registers.....	32

6 Contents

Clearing the Financial Registers	33
Simple Interest Calculations.....	33
Financial Calculations and the Cash Flow Diagram.....	34
The Cash Flow Sign Convention.....	36
The Payment Mode	37
Generalized Cash Flow Diagrams.....	37
Compound Interest Calculations.....	39
Specifying the Number of Compounding Periods and the Periodic Interest Rate	39
Calculating the Number of Payments or Compounding Periods ...	39
Calculating the Periodic and Annual Interest Rates.....	43
Calculating the Present Value	44
Calculating the Payment Amount.....	46
Calculating the Future Value	48
Odd-Period Calculations	50
Amortization	54
Section 4: Additional Financial Functions	57
Discounted Cash Flow Analysis: NPV and IRR	57
Calculating Net Present Value (NPV)	58
Calculating Internal Rate of Return (IRR)	63
Reviewing Cash Flow Entries.....	64
Changing Cash Flow Entries.....	65
Bond Calculations	66
Bond Price	67
Bond Yield	67
Depreciation Calculations	68
Section 5: Additional Operating Features	70
Continuous Memory.....	70
The Display.....	71
Status Indicators	71
Number Display Formats	71
Scientific Notation Display Format.....	72
Special Displays	73
The $\boxed{x \div y}$ key	74
The \boxed{LSTx} Key.....	74
Arithmetic Calculations With Constants.....	75
Recovering From Errors in Digit Entry	75

Section 6: Statistics Functions.....	76
Accumulating Statistics.....	76
Correcting Accumulated Statistics	77
Mean	77
Standard Deviation.....	79
Linear Estimation	80
Weighted Mean.....	81
Section 7: Mathematics and Number-Alteration Functions	83
One-Number Functions	83
The Power Function	85
Part II. Programming	87
Section 8: Programming Basics	88
Why Use Programs?.....	88
Creating a Program.....	88
Running a Program.....	89
Program Memory	90
Identifying Instructions in Program Lines	91
Displaying Program Lines.....	92
The $\text{GTO}00$ Instruction and Program Line 00	93
Expanding Program Memory	94
Setting the Calculator to a Particular Program Line	95
Executing a Program One Line at a Time	96
Interrupting Program Execution.....	97
Pausing During Program Execution	97
Stopping Program Execution	101
Section 9: Branching and Looping	103
Simple Branching	103
Looping	104
Conditional Branching	107
Section 10: Program Editing	113
Changing the Instruction in a Program Line	113
Adding Instructions at the End of a Program	114
Adding Instructions Within a Program	115
Adding Instructions by Replacement.....	115
Adding Instructions by Branching.....	116

8 Contents

Section 11: Multiple Programs	120
Storing Another Program	120
Running Another Program	122
Part III. Solutions	123
Section 12: Real Estate and Lending	124
Annual Percentage Rate Calculations With Fees.....	124
Price of a Mortgage Traded at a Discount or Premium.....	126
Yield of a Mortgage Traded at a Discount or Premium	128
The Rent or Buy Decision	130
Deferred Annuities	134
Section 13: Investment Analysis	136
Partial-Year Depreciation.....	136
Straight-Line Depreciation.....	136
Declining-Balance Depreciation	139
Sum-of-the-Years-Digits Depreciation	141
Full- and Partial-Year Depreciation with Crossover	144
Excess Depreciation	148
Modified Internal Rate of Return.....	148
Section 14: Leasing	151
Advance Payments	151
Solving For Payment	151
Solving for Yield	154
Advance Payments With Residual	156
Solving for Payment.....	156
Solving For Yield.....	158
Section 15: Savings.....	160
Nominal Rate Converted to Effective Rate	160
Effective Rate Converted to Nominal Rate	161
Nominal Rate Converted to Continuous Effective Rate.....	162
Section 16: Bonds	163
30/360 Day Basis Bonds.....	163
Annual Coupon Bonds	166

Appendixes 169

Appendix A: The Automatic Memory Stack 170

- Getting Numbers Into the Stack: The **ENTER** Key.....171
 - Termination of Digit Entry172
 - Stack Lift.....172
- Rearranging Numbers in the Stack172
 - The **X \leftrightarrow Y** key172
 - The **R \downarrow** Key.....172
- One-Number Functions and the Stack173
- Two-Number Functions and the Stack.....173
 - Mathematics Functions173
 - Percentage Functions.....174
 - Calendar and Financial Functions.....175
- The LAST X Register and the **LSTX** Key176
- Chain Calculations176
- Arithmetic Calculations with Constants177

Appendix B: More About **IRR..... 179**

Appendix C: Error Conditions 181

- Error 0: Mathematics181
- Error 1: Storage Register Overflow182
- Error 2: Statistics182
- Error 3: IRR.....182
- Error 4: Memory182
- Error 5: Compound Interest.....183
- Error 6: Storage Registers183
- Error 7: IRR.....184
- Error 8: Calendar.....184
- Error 9: Service184
- Pr Error184

Appendix D: Formulas Used 185

- Percentage185
- Interest185
 - Simple Interest.....185
 - Compound Interest.....186
- Amortization.....186
- Discounted Cash Flow Analysis187
 - Net Present Value187
 - Internal Rate of Return187
- Calendar187
 - Actual Day Basis187

10 Contents

30/360 Day Basis.....	187
Bonds	188
Depreciation	189
Straight-Line Depreciation.....	189
Sum-of-the-Years-Digits Depreciation	189
Declining-Balance Depreciation	190
Modified Internal Rate of Return.....	190
Advance Payments.....	190
Interest Rate Conversions	191
Finite Compounding.....	191
Continuous Compounding.....	191
Statistics	191
Mean	191
Weighted Mean	191
Linear Estimation.....	191
Standard Deviation	192
Factorial	192
The Rent or Buy Decision	192
Appendix E: Battery, Warranty, and Service Information	193
Battery	193
Low-Power Indication.....	193
Installing a New Battery	193
Verifying Proper Operation (Self-Tests)	194
Warranty.....	196
Service.....	197
Regulatory Information	199
Temperature Specifications.....	199
Noise Declaration	199
Disposal of Waste Equipment by Users in Private Household in the European Union	200
Appendix F: United Kingdom Calculations	201
Mortgages.....	201
Annual Percentage Rate (APR) Calculations	202
Bond Calculations	202
Function Key Index.....	203
Programming Key Index	206
Subject Index.....	208

Making Financial Calculations Easy

Before you begin to read through this handbook, let's take a look at how easy financial calculations can be with your hp 12c. While working through the examples below, don't be concerned about learning how to use the calculator; we'll cover that thoroughly beginning with Section 1.

Example 1: Suppose you want to ensure that you can finance your daughter's college education 14 years from today. You expect that the cost will be about \$6,000 a year (\$500 a month) for 4 years. Assume she will withdraw \$500 at the beginning of each month from a savings account. How much would you have to deposit into the account when she enters college if the account pays 6% annual interest compounded monthly?

This is an example of a compound interest calculation. All such problems involve at least three of the following quantities:

- n : the *number* of compounding periods.
- i : the *interest rate* per compounding period.
- PV : the *present value* of a compounded amount.
- PMT : the *periodic payment* amount.
- FV : the *future value* of a compounded amount.

In this particular example:

- n is 4 years \times 12 periods per year = 48 periods.
- i is 6% per year \div 12 periods per year = 0.5% per period.
- PV is the quantity to be calculated — the present value when the financial transaction begins.
- PMT is \$500.
- FV is zero, since by the time your daughter graduates she (hopefully!) will not need any more money.

To begin, turn the calculator on by pressing the **ON** key. Then, press the keys shown in the **Keystrokes** column below.*

* If you are not familiar with the use of an hp calculator keyboard, refer to the description on pages 16 and 17.

12 Making Financial Calculations Easy

Note: A battery symbol (✱) shown in the lower-left corner of the display when the calculator is on signifies that the available battery power is nearly exhausted. To install new batteries, refer to Appendix E.

The calendar functions and nearly all of the financial functions take some time to produce an answer. (This is typically just a few seconds, but the \boxed{i} , $\boxed{\text{AMORT}}$, $\boxed{\text{IRR}}$, and $\boxed{\text{YTM}}$ functions could require a half-minute or more.) During these calculations, the word **running** flashes in the display to let you know that the calculator is running.

Keystrokes	Display	
\boxed{f} CLEAR $\boxed{\text{REG}}$ \boxed{f} 2	0 . 00	Clears previous data inside the calculator and sets display to show two decimal places.
4 \boxed{g} $\boxed{12X}$	48 . 00	Calculates and stores the number of compounding periods.
6 \boxed{g} $\boxed{12\div}$	0 . 50	Calculates and stores the periodic interest rate.
500 $\boxed{\text{PMT}}$	500 . 00	Stores periodic payment amount.
\boxed{g} $\boxed{\text{BEG}}$	500 . 00	Sets payment mode to Begin.
$\boxed{\text{PV}}$	-21 , 396 . 61	Amount required to be deposited.*

Example 2: We now need to determine how to accumulate the required deposit by the time your daughter enters college 14 years from now. Let's say that she has a paid-up \$5,000 insurance policy that pays 5.35% annually, compounded semiannually. How much would it be worth by the time she enters college?

In this example, we need to calculate *FV*, the future value.

Keystrokes	Display	
\boxed{f} CLEAR $\boxed{\text{FIN}}$	-21 , 396 . 61	Clears previous financial data inside the calculator.
14 $\boxed{\text{ENTER}}$ 2 \boxed{X} \boxed{n}	28 . 00	Calculates and stores the number of compounding periods.
5.35 $\boxed{\text{ENTER}}$ 2 $\boxed{\div}$ \boxed{i}	2 . 68	Calculates and stores the periodic interest rate.
5000 $\boxed{\text{CHS}}$ $\boxed{\text{PV}}$	-5 , 000 . 00	Stores the present value of the policy.
$\boxed{\text{FV}}$	10 , 470 . 85	Value of policy in 14 years.

* Don't be concerned now about the minus sign in the display. That and other details will be explained in Section 3.

Example 3: The preceding example showed that the insurance policy will provide about half the required amount. An additional amount must be set aside to provide the balance ($21,396.61 - 10,470.85 = 10,925.76$). Suppose you make monthly payments, beginning at the end of next month, into an account that pays 6% annually, compounded monthly. What payment amount would be required in order to accumulate \$10,925.75 in the 14 years remaining?

Keystrokes	Display	
f CLEAR FIN	10,470.85	Clears previous financial data inside the calculator.
14 g 12X	168.00	Calculates and stores the number of compounding periods.
6 g 12÷	0.50	Calculates and stores the periodic interest rate.
10925.76 FV	10,925.76	Stores the future value required.
g END	10,925.76	Sets payment mode to End.
PMT	-41.65	Monthly payment required.

Example 4: Suppose you cannot find a bank that currently offers an account with 6% annual interest compounded monthly, but you can afford to make \$45.00 monthly payments. What is the minimum interest rate that will enable you to accumulate the required amount?

In this problem, we do not need to clear the previous financial data inside the calculator, since most of it is unchanged from the preceding example.

Keystrokes	Display	
45 CHS PMT	-45.00	Stores payment amount.
i	0.42	Periodic interest rate.
12 X	5.01	Annual interest rate.

This is only a small sampling of the many financial calculations that can now be done easily with your hp 12c. To begin learning about this powerful financial tool, just turn the page.

Part I

Problem Solving

Section 1

Getting Started

Power On and Off

To begin using your hp 12c, press the **ON** key*. Pressing **ON** again turns the calculator off. If not manually turned off, the calculator will turn off automatically 8 to 17 minutes after it was last used.

Low-Power Indication

A battery symbol (✳) shown in the upper-left corner of the display when the calculator is on signifies that the available battery power is nearly exhausted. To replace the batteries, refer to Appendix E.

The Keyboard

Many keys on the hp 12c perform two or even three functions. The primary function of a key is indicated by the characters printed in white on the upper face of the key. The alternate function(s) of a key are indicated by the characters printed in gold above the key and the characters printed in blue on the lower face of the key. These alternate functions are specified by pressing the appropriate *prefix* key before the function key:

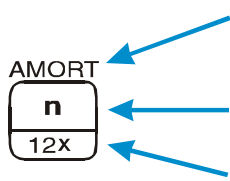
- 
- To specify the alternate function printed in gold above a key, press the gold prefix key (**f**), then press the function key.
 - To specify the primary function printed on the upper face of a key, press the key alone.
 - To specify the alternate function printed in blue on the lower face of a key, press the blue prefix key (**g**), then press the function key.

* Note that the **ON** key is lower than the other keys to help prevent its being pressed inadvertently.

Throughout this handbook, references to the *operation* of an alternate function appear as only the function name in a box (for example, “The **IRR** function ...”). References to the *selection* of an alternate function appear preceded by the appropriate prefix key (for example, “Pressing **f****IRR** ...”). References to the functions shown on the keyboard in gold under the bracket labeled “CLEAR” appear throughout this handbook preceded by the word “CLEAR” (for example, “The CLEAR**REG** function ...” or “Pressing **f**CLEAR**REG** ...”).

If you press the **f** or **g** prefix key mistakenly, you can cancel it by pressing **f**CLEAR**PREFIX**. This can also be pressed to cancel the **STO**, **RCL**, and **GTO** keys. (These keys are “prefix” keys in the sense that other keys must be pressed after them in order to execute the corresponding function.) Since the **PREFIX** key is also used to display the mantissa (all 10 digits) of a displayed number, the mantissa of the number in the display will appear for a moment after the **PREFIX** key is released.

Pressing the **f** or **g** prefix key turns on the corresponding status indicator — **f** or **g** — in the display. Each indicator turns off when you press a function key (executing an alternate function of that key), another prefix key, or **f**CLEAR**PREFIX**.

Keying in Numbers

To key a number into the calculator, press the digit keys in sequence, just as if you were writing the number on paper. A decimal point must be keyed in (using the decimal point key) if it is part of the number unless it appears to the right of the last digit.

Digit Separators

As a number is keyed in, each group of three digits to the left of the decimal point is automatically separated in the display. When the calculator is first turned on after coming from the factory — or after Continuous Memory is reset — the decimal point in displayed numbers is a dot, and the separator between each group of three digits is a comma. If you wish, you can set the calculator to display a comma for the decimal point and a dot for the three-digit separator. To do so, turn the calculator off, then press and hold down the **□** key while you press **ON**. Doing so again sets the calculator to use the original digit separators in the display.

Negative Numbers

To make a displayed number negative — either one that has just been keyed in or one that has resulted from a calculation — simply press **CHS** (*change sign*). When the display shows a negative number — that is, the number is preceded by a minus sign — pressing **CHS** removes the minus sign from the display, making the number positive.

18 Section 1: Getting Started

Keying in Large Numbers

Since the display cannot show more than 10 digits of a number, numbers greater than 9,999,999,999 cannot be entered into the display by keying in all the digits in the number. However, such numbers can be easily entered into the display if the number is expressed in a mathematical shorthand called "scientific notation." To convert a number into scientific notation, move the decimal point until there is only one digit (a nonzero digit) to its left. The resulting number is called the "mantissa" of the original number, and the number of decimal places you moved the decimal point is called the "exponent" of the original number. If you moved the decimal point to the left, the exponent is positive; if you moved the decimal point to the right (this would occur for numbers less than one), the exponent is negative. To key the number into the display, simply key in the mantissa, press $\boxed{\text{EEX}}$ (*enter exponent*), then key in the exponent. If the exponent is negative, press $\boxed{\text{CHS}}$ after pressing $\boxed{\text{EEX}}$.

For example, to key in \$1,781,400,000,000, we move the decimal point 12 places to the left, giving a mantissa of 1.7814 and an exponent of 12:

Keystrokes	Display
1.7814 $\boxed{\text{EEX}}$ 12	1.7814 12 1,781,400,000,000 entered in scientific notation.

Numbers entered in scientific notation can be used in calculations just like any other number.

The CLEAR Keys

Clearing a register or the display replaces the number in it with zero. Clearing program memory replaces the instructions there with $\boxed{\text{G}}$ $\boxed{\text{GTO}}$ 00. There are several clearing operations on the hp 12c, as shown in the table below:

Key(s)	Clears:
$\boxed{\text{CLX}}$	Display and X-register.
$\boxed{\text{f}}$ $\boxed{\text{CLEAR}}$ $\boxed{\Sigma}$	Statistics registers (R_1 through R_6), stack registers, and display.
$\boxed{\text{f}}$ $\boxed{\text{CLEAR}}$ $\boxed{\text{PRGM}}$	Program memory (only when pressed in Program mode).
$\boxed{\text{f}}$ $\boxed{\text{CLEAR}}$ $\boxed{\text{FIN}}$	Financial registers.
$\boxed{\text{f}}$ $\boxed{\text{CLEAR}}$ $\boxed{\text{REG}}$	Data storage registers, financial registers, stack and LAST X registers, and display.

Simple Arithmetic Calculations

Any simple arithmetic calculation involves two numbers and an operation — addition, subtraction, multiplication, or division. To do such a calculation on your hp 12c, you first tell the calculator the two numbers, *then* tell the calculator the operation to be performed. The answer is calculated when the operation key (\oplus , \ominus , \otimes , or \div) is pressed.

The two numbers should be keyed into the calculator in the order they would appear if the calculation were written down on paper left-to-right. After keying in the first number, press the ENTER key to tell the calculator that you have completed entering the number. Pressing ENTER separates the second number to be entered from the first number already entered.

In summary, to perform an arithmetic operation:

1. Key in the first number.
2. Press ENTER to separate the second number from the first.
3. Key in the second number.
4. Press \oplus , \ominus , \otimes , or \div to perform the desired operation.

For example to calculate $13 \div 2$, proceed as follows:

Keystrokes	Display	
13	13 .	Keys the first number into the calculator.
ENTER	13 . 00	Pressing ENTER separates the second number from the first.
2	2 .	Keys the second number into the calculator.
\div	6 . 50	Pressing the operation key calculates the answer.

Notice that after you pressed ENTER , two zeroes appeared following the decimal point. This is nothing magical: the calculator's display is currently set to show two decimal places of every number that has been entered or calculated. Before you pressed ENTER , the calculator had no way of knowing that you had completed entering the number, and so displayed only the digits you had keyed in. Pressing ENTER tells the calculator that you have completed entering the number: it *terminates digit entry*. You need not press ENTER after keying in the second number because the \oplus , \ominus , \otimes and \div keys also terminate digit entry. (In fact, all keys terminate digit entry except for digit entry keys — digit keys, \square , CHS , and EEX — and prefix keys — f , g , STO , RCL , and GTO .)

Chain Calculations

Whenever the answer has just been calculated and is therefore in the display, you can perform another operation with this number by simply keying in the second number and then pressing the operation key: you need *not* press **ENTER** to separate the second number from the first. This is because when a number is keyed in after a function key (such as **+**, **-**, **×**, **÷**, etc.) is pressed, the result of that prior calculation is stored inside the calculator — just as when the **ENTER** key is pressed. *The only time you must press the **ENTER** key to separate two numbers is when you are keying them both in, one immediately following the other.*

The hp 12c is designed so that each time you press a function key in RPN mode, the calculator performs the operation *then* — not later — so that you see the results of all intermediate calculations, as well as the “bottom line.”

Example: Suppose you’ve written three checks without updating your checkbook, and you’ve just deposited your paycheck for \$1,053.00 into your checking account. If your latest balance was \$58.33 and the checks were written for \$22.95, \$13.70, and \$10.14, what is the new balance?

Solution: When written down on paper, this problem would read

$$58.33 - 22.95 - 13.70 - 10.14 + 1053$$

Keystrokes	Display	
58.33	58 . 33	Keys the first number.
ENTER	58 . 33	Pressing ENTER separates the second number from the first.
22.95	22 . 95	Keys in the second number.
-	35 . 38	Pressing - subtracts the second number from the first. The calculator displays the result of this calculation, which is the balance after subtracting the first check.
13.70	13 . 70	Keys in the next number. Since a calculation has just been performed, do not press ENTER ; the next number entered (13.70) is automatically separated from the one previously in the display (35.38).

Keystrokes	Display	
\square	21.68	Pressing \square subtracts the number just entered from the number previously in the display. The calculator displays the result of this calculation, which is the balance after subtracting the second check.
10.14 \square	11.54	Keys in the next number and subtracts it from the previous balance. The new balance appears in the display. (It's getting rather low!)
1053 \oplus	1,064.54	Keys in the next number — the paycheck deposited — and adds it to the previous balance. The new, current balance appears in the display.

The preceding example demonstrates how the hp 12c calculates just as you would using pencil and paper (except a lot faster!):

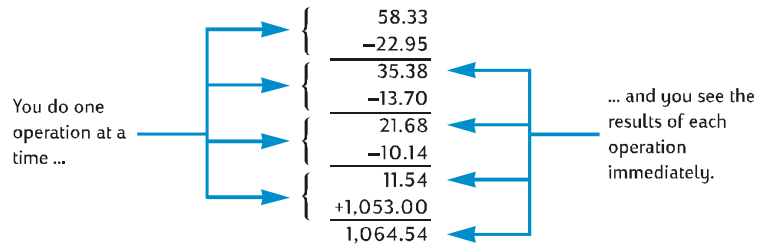

Let's see this happening in a different type of calculation — one that involves multiplying groups of two numbers and then adding the results. (This is the type of calculation that would be required to total up an invoice consisting of several items with different quantities and different prices.)

For example, consider the calculation of $(3 \times 4) + (5 \times 6)$. If you were doing this on paper, you would first do the multiplication in the first parentheses, then the multiplication in the second parentheses, and finally add the results of the two multiplications:

$$\begin{array}{l}
 \cancel{(3 \times 4)} + \cancel{(5 \times 6)} \\
 \textcircled{1} 12 + \textcircled{2} 30 \\
 \textcircled{3} 42
 \end{array}$$

22 Section 1: Getting Started

Your hp 12c calculates the answer in just the same way:

Keystrokes	Display	
3 \square ENTER4 \square X	12.00	Step 1: Multiply the numbers in the first parentheses.
5 \square ENTER6 \square X	30.00	Step 2: Multiply the numbers in the second parentheses.
\square +	42.00	Step 3: Add the results of the two multiplications.

Notice that before doing step 2, you did not need to store or write down the result of step 1: it was stored inside the calculator automatically. And after you keyed in the 5 and the 6 in step 2, the calculator was holding two numbers (12 and 5) inside for you, in addition to the 6 in the display. (The hp 12c can hold a total of three numbers inside, in addition to the number in the display.) After step 2, the calculator was still holding the 12 inside for you, in addition to the 30 in the display. You can see that the calculator holds the number for you, just as you would have them written on paper, and then calculates with them at the proper time, just as you would yourself.* But with the hp 12c, you don't need to write down the results of an intermediate calculation, and you don't even need to manually store it and recall it later.

By the way, notice that in step 2 you needed to press \square ENTER again. This is simply because you were again keying in two numbers immediately following each other, without performing a calculation in between.

To check your understanding of how to calculate with your hp 12c, try the following problems yourself. Although these problems are relatively simple, more complicated problems can be solved using the same basic steps. If you have difficulty obtaining the answers shown, review the last few pages.

$$(3 + 4) \times (5 + 6) = 77.00$$

$$\frac{(27 - 14)}{(14 + 38)} = 0.25$$

$$\frac{5}{3 + 16 + 21} = 0.13$$

* Although you don't *need* to know just how these numbers are stored and brought back at just the right time, if you're interested you can read all about it in Appendix A. By gaining a more complete understanding of the calculator's operation, you'll use it more efficiently and confidently, yielding a better return on the investment in your hp 12c.

Storage Registers

Numbers (data) in the hp 12c are stored in memories called “storage registers” or simply “registers.” (The singular term “memory” is sometimes used in this handbook to refer to the entire collection of storage registers.) Four special registers are used for storing numbers during calculations (these “stack registers” are described in Appendix A), and another (called the “LAST X” register) is used for storing the number last in the display before an operation is performed. In addition to these registers into which numbers are stored automatically, up to 20 “data storage” registers are available for manual storage of numbers. These data storage registers are designated R_0 through R_9 and R_{10} through R_{19} . Fewer registers are available for data storage if a program has been stored in the calculator (since the program is stored in some of those 20 registers), but a minimum of 7 registers is always available. Still other storage registers — referred to as the “financial registers” — are reserved for numbers used in financial calculations.

Storing and Recalling Numbers

To store the number from the display into a data storage register:

1. Press $\boxed{\text{STO}}$ (*store*).
2. Key in the register number: 0 through 9 for registers R_0 through R_9 , or $\boxed{\cdot}0$ through $\boxed{\cdot}9$ for registers R_{10} through R_{19} .

Similarly, to recall a number from a storage register into the display, press $\boxed{\text{RCL}}$ (*recall*), then key in the register number. This copies the number from the storage register into the display; the number remains unaltered in the storage register. Furthermore, when this is done, the number previously in the display is automatically held inside the calculator for a subsequent calculation, just as the number in the display is held when you key in another number.

Example: Before you leave to call on a customer interested in your personal computer, you store the cost of the computer (\$3,250) and also the cost of a printer (\$2,500) in data storage registers. Later, the customer decides to buy six computers and one printer. You recall the cost of the computer, multiply by the quantity ordered, and then recall and add the cost of the printer to get the total invoice.

Keystrokes	Display	
3250 $\boxed{\text{STO}}$ 1	3,250.00	Stores the cost of the computer in R_1 .
2500 $\boxed{\text{STO}}$ 2	2,500.00	Stores the cost of the printer in R_2 .
$\boxed{\text{ON}}$		Turns the calculator off.

24 Section 1: Getting Started

Later that same day ...

Keystrokes	Display	
$\boxed{\text{ON}}$	2,500.00	Turns the calculator back on.
$\boxed{\text{RCL}}\ 1$	3,250.00	Recalls the cost of the computer to the display.
6 $\boxed{\times}$	19,500.00	Multiplies the quantity ordered to get the cost of the computers.
$\boxed{\text{RCL}}\ 2$	2,500.00	Recalls the cost of the printer to the display.
$\boxed{+}$	22,000.00	Total invoice.

Clearing Storage Registers

To clear a single storage register — that is, to replace the number in it with zero — merely store zero into it. You need not clear a storage register before storing data into it; the storing operation automatically clears the register before the data is stored.

To clear *all* storage registers at once — including the financial registers, the stack registers, and the LAST X register — press $\boxed{\text{f}}\ \boxed{\text{CLEAR}}\ \boxed{\text{REG}}$. * This also clears the display.

All storage registers are also cleared when Continuous Memory is reset (as described on page 70).

Storage Register Arithmetic

Suppose you wanted to perform an arithmetic operation with the number in the display and the number in a storage register, then store the result back into the same register without altering the number in the display. The hp 12c enables you to do all this in a single operation:

1. Press $\boxed{\text{STO}}$.
2. Press $\boxed{+}$, $\boxed{-}$, $\boxed{\times}$, or $\boxed{\div}$ to specify the desired operation.
3. Key in the register number.

When storage register arithmetic is performed, the new number in the register is determined according to the following rule:

$$\text{number now in register} = \text{number formerly in register} \left\{ \begin{array}{l} + \\ - \\ \times \\ \div \end{array} \right\} \text{number in display}$$

* CLEAR $\boxed{\text{REG}}$ is not programmable.

Storage register arithmetic is possible with only registers R_0 through R_4 .

Example: In the example on page 20, we updated the balance in your checkbook. Let's suppose that because data is stored indefinitely in your calculator's Continuous Memory, you keep track of your checking account balance in the calculator. You could use storage register arithmetic to quickly update the balance after depositing or writing checks.

Keystrokes	Display	
58.33 $\boxed{\text{STO}}$ $\boxed{0}$	58.33	Stores the current balance in register R_0 .
22.95 $\boxed{\text{STO}}$ $\boxed{-}$ $\boxed{0}$	22.95	Subtracts the first check from the balance in R_0 . Note that the display continues to show the amount subtracted; the answer is placed only in R_0 .
13.70 $\boxed{\text{STO}}$ $\boxed{-}$ $\boxed{0}$	13.70	Subtracts the second check.
10.14 $\boxed{\text{STO}}$ $\boxed{-}$ $\boxed{0}$	10.14	Subtracts the third check.
1053 $\boxed{\text{STO}}$ $\boxed{+}$ $\boxed{0}$	1,053.00	Adds the deposit.
$\boxed{\text{RCL}}$ $\boxed{0}$	1,064.54	Recalls the number in R_0 to check the new balance.

Section 2

Percentage and Calendar Functions

Percentage Functions

The hp 12c includes three keys for solving percentage problems: $\boxed{\%}$, $\boxed{\Delta\%}$, and $\boxed{\%T}$. You don't need to convert percentages to their decimal equivalents; this is done automatically when you press any of these keys. Thus, 4% need not be changed to 0.04; you key it in the way you see and say it: 4 $\boxed{\%}$.

Percentages

To find the amount corresponding to a percentage of a number:

1. Key in the base number.
2. Press $\boxed{\text{ENTER}}$.
3. Key in the percentage.
4. Press $\boxed{\%}$.

For example, to find 14% of \$300:

Keystrokes	Display	
300	300 .	Keys in the base number.
$\boxed{\text{ENTER}}$	300 .00	Pressing $\boxed{\text{ENTER}}$ separates the next number entered from the first number, just as when an ordinary arithmetic calculation is performed.
14	14 .	Keys in the percentage.
$\boxed{\%}$	42 .00	Calculates the amount.

If the base number is already in the display as a result of a previous calculation, you should not press $\boxed{\text{ENTER}}$ before keying in the percentage — just as in a chain arithmetic calculation.

Net Amount

A net amount — that is, the base amount plus or minus the percentage amount — can be calculated easily with your hp 12c, since the calculator holds the base amount inside after you calculate a percentage amount. To calculate a net amount, simply calculate the percentage amount, then press $\boxed{+}$ or $\boxed{-}$.

Example: You're buying a new car that lists for \$13,250. The dealer offers you a discount of 8%, and the sales tax is 6%. Find the amount the dealer is charging you, then find the total cost to you, including tax.

Keystrokes	Display	
13250 $\boxed{\text{ENTER}}$	13,250.00	Keys in the base amount and separates it from the percentage.
8 $\boxed{\%}$	1,060.00	Amount of discount.
$\boxed{-}$	12,190.00	Base amount less discount.
6 $\boxed{\%}$	731.40	Amount of tax (on \$12,190).
$\boxed{+}$	12,921.40	Total cost: base amount less discount plus tax.

Percent Difference

To find the percent difference between two numbers:

1. Key in the base number.
2. Press $\boxed{\text{ENTER}}$ to separate the other number from the base number.
3. Key in the other number.
4. Press $\boxed{\Delta\%}$.

If the other number is greater than the base number, the percent difference will be positive. If the other number is less than the base number, the percent difference will be negative. Therefore, a positive answer indicates an increase, while a negative answer indicates a decrease.

If you are calculating a percent difference over time, the base number is typically the amount occurring first.

Example: Yesterday your stock fell from $58\frac{1}{2}$ to $53\frac{1}{4}$ per share. What is the percent change?

Keystrokes	Display	
58.5 $\boxed{\text{ENTER}}$	58.50	Keys in the base number and separates it from the other number.
53.25	53.25	Keys in the other number.
$\boxed{\Delta\%}$	-8.97	Nearly a 9% decrease.

28 Section 2: Percentage and Calendar Functions

The $\Delta\%$ key can be used for calculations of the percent difference between a wholesale cost and a retail cost. If the base number entered is the wholesale cost, the percent difference is called the *markup*; if the base number entered is the retail cost, the percent difference is called the *margin*. Examples of markup and margin calculations are included in the *hp 12c Solutions Handbook*.

Percent of Total

To calculate what percentage one number is of another:

1. Calculate the total amount by adding the individual amounts, just as in a chain arithmetic calculation.
2. Key in the number whose percentage equivalent you wish to find.
3. Press $\%T$.

Example: Last month, your company posted sales of \$3.92 million in the U.S., \$2.36 million in Europe, and \$1.67 million in the rest of the world. What percentage of the total sales occurred in Europe?

Keystrokes	Display	
3.92 ENTER	3 . 92	Keys in the first number and separates it from the second.
2.36 +	6 . 28	Adds the second number.
1.67 +	7 . 95	Adds the third number to get the total.
2.36	2 . 36	Keys in 2.36 to find what percentage it is of the number in the display.
$\%T$	29 . 69	Europe had nearly 30% of the total sales.

The hp 12c holds the total amount inside after a percent of total is calculated. Therefore, to calculate what percentage *another* amount is of the total:

1. Clear the display by pressing CLx .
2. Key in that amount.
3. Press $\%T$ again.

For example, to calculate what percent of the total sales in the preceding example occurred in the U.S. and what percent occurred in the rest of the world:

Keystrokes	Display	
CLx 3.92 $\%T$	49 . 31	The U.S. had about 49% of the total sales.
CLx 1.67 $\%T$	21 . 01	The rest of the world had about 21% of the total sales.

To find what percentage a number is of a total, when you already know the total number:

1. Key in the total number.
2. Press **ENTER** to separate the other number from the total number.
3. Key in the number whose percentage equivalent you wish to find.
4. Press **%T**.

For example, if you already knew in the preceding example that the total sales were \$7.95 million and you wanted to find what percentage of that total occurred in Europe:

Keystrokes	Display	
7.95 ENTER	7 . 95	Keys in the total amount and separates it from the next number.
2.36	2 . 36	Keys in 2.36 to find what percentage it is of the number in the display.
%T	29 . 69	Europe had nearly 30% of the total sales.

Calendar Functions

The calendar functions provided by the hp 12c — **DATE** and **ADYS** — can handle dates from October 15, 1582 through November 25, 4046.

Date Format

For each of the calendar functions — and also for bond calculations (**PRICE** and **YTM**) — the calculator uses one of two date formats. The date format is used to interpret dates when they are keyed into the calculator as well as for displaying dates.

Month-Day-Year. To set the date format to month-day-year, press **9** **M.DY**. To key in a date with this format in effect:

1. Key in the one or two digits of the month.
2. Press the decimal point key (**.**).
3. Key in the two digits of the day.
4. Key in the four digits of the year.

Dates are displayed in the same format.

For example, to key in April 7, 2004:

Keystrokes	Display
4.072004	4 . 072004

30 Section 2: Percentage and Calendar Functions

Day-Month-Year. To set the date format to day-month-year, press $\boxed{g} \boxed{DMY}$. To key in a date with this format in effect:

1. Key in the one or two digits of the day.
2. Press the decimal point key ($\boxed{\cdot}$).
3. Key in the two digits of the month.
4. Key in the four digits of the year.

For example, to key in 7 April, 2004:

Keystrokes	Display
7.042004	7.042004

When the date format is set to day-month-year, the **D.MY** status indicator in the display is lit. If **D.MY** is not lit, the date format is set to month-day-year.

The date format remains set to what you last specified until you change it; it is not reset each time the calculator is turned on. However, if Continuous Memory is reset, the date format is set to month-day-year.

Future or Past Dates

To determine the date and day that is a given number of days from a given date:

1. Key in the given date and press \boxed{ENTER} .
2. Key in the number of days.
3. If the other date is in the past, press \boxed{CHS} .
4. Press $\boxed{g} \boxed{DATE}$.

The answer calculated by the \boxed{DATE} function is displayed in a special format. The numbers of the month, day, and year (or day, month, and year) are separated by digit separators, and the digit at the right of the displayed answer indicates the day of the week: 1 for Monday through 7 for Sunday.*

Example: If you purchased a 120-day option on a piece of land on 14 May 2004, what would be the expiration date? Assume that you normally express dates in the day-month-year format.

Keystrokes	Display
$\boxed{g} \boxed{DMY}$	7.04

Sets date format to day-month-year. (Display shown assumes date remains from preceding example. The full date is not now displayed because the display format is set to show only two decimal places, as described in Section 5.)

* The day of the week indicated by the \boxed{DATE} function may differ from that recorded in history for dates when the Julian calendar was in use. The Julian calendar was standard in England and its colonies until September 14, 1752, when they switched to the Gregorian calendar. Other countries adopted the Gregorian calendar at various times.

Keystrokes	Display	
14.052004 \square ENTER	14 . 05	Keys in date and separates it from number of days to be entered.
120 \square g \square DATE	11 , 09 , 2004 6	The expiration date is 11 September 2004, a Saturday.

When \square DATE is executed as an instruction in a running program, the calculator pauses for about 1 second to display the result, then resumes program execution.

Number of Days Between Dates

To calculate the number of days between two given dates:

1. Key in the earlier date and press \square ENTER.
2. Key in the later date and press \square g \square ADYS.

The answer shown in the display is the actual number of days between the two dates, including leap days (the extra days occurring in leap years), if any. In addition, the hp 12c also calculates the number of days between the two dates on the basis of a 30-day month. This answer is held inside the calculator; to display it, press \square x \square y. Pressing \square x \square y again will return the original answer to the display.

Example: Simple interest calculations can be done using either the actual number of days or the number of days counted on the basis of a 30-day month. What would be the number of days counted each way, to be used in calculating the simple interest accruing from June 3, 2004 to October 14, 2005? Assume that you normally express dates in the month-day-year format.

Keystrokes	Display	
\square g \square M.DY	11 . 09	Sets date format to month-day-year. (Display shown assumes date remains from preceding example.)
6.032004 \square ENTER	6 . 03	Keys in earlier date and separates it from the later date.
10.142005 \square g \square ADYS	498 . 00	Keys in later date. Display shows actual number of days.
\square x \square y	491 . 00	Number of days counted on the basis of a 30-day month.

Section 3

Basic Financial Functions

The Financial Registers

In addition to the data storage registers discussed on page 23, the hp 12c has five special registers in which numbers are stored for financial calculations. These registers are designated n, i, PV, PMT, and FV. The first five keys on the top row of the calculator are used to store a number from the display into the corresponding register, to calculate the corresponding financial value and store the result into the corresponding register, or to display the number stored in the corresponding register.*

Storing Numbers Into the Financial Registers

To store a number into a financial register, key the number into the display, then press the corresponding key (\boxed{n} , \boxed{i} , \boxed{PV} , \boxed{PMT} , or \boxed{FV}).

Displaying Numbers in the Financial Registers

To display a number stored in a financial register, press \boxed{RCL} followed by the corresponding key.†

* Which operation is performed when one of these keys is pressed depends upon the last preceding operation performed: If a number was just stored into a financial register (using \boxed{n} , \boxed{i} , \boxed{PV} , \boxed{PMT} , \boxed{FV} , $\boxed{12X}$, or $\boxed{12\div}$), pressing one of these five keys calculates the corresponding value and stores it into the corresponding register; otherwise pressing one of these five keys merely stores the number from the display into the corresponding register.

† It's good practice to press the corresponding key *twice* after \boxed{RCL} , since often you may want to calculate a financial value right after displaying another financial value. As indicated in the preceding footnote, if you wanted to display *FV* and then calculate *PV*, for example, you should press $\boxed{RCL}\boxed{FV}\boxed{FV}\boxed{PV}$. If you didn't press \boxed{FV} the second time, pressing \boxed{PV} would store *FV* in the PV register rather than calculating *PV*, and to calculate *PV* you would have to press \boxed{PV} again.

Clearing the Financial Registers

Every financial function uses numbers stored in several of the financial registers. Before beginning a new financial calculation, it is good practice to clear all of the financial registers by pressing $\boxed{f}\boxed{CLEAR}\boxed{FIN}$. Frequently, however, you may want to repeat a calculation after changing a number in only one of the financial registers. To do so, do not press $\boxed{f}\boxed{CLEAR}\boxed{FIN}$; instead, simply store the new number in the register. The numbers in the other financial registers remain unchanged.

The financial registers are also cleared when you press $\boxed{f}\boxed{CLEAR}\boxed{REG}$ and when Continuous Memory is reset (as described on page 70).

Simple Interest Calculations

The hp 12c simultaneously calculates simple interest on both a 360-day basis and a 365-day basis. You can display either one, as described below. Furthermore, with the accrued interest in the display, you can calculate the total amount (principal plus accrued interest) by pressing $\boxed{+}$.

1. Key in or calculate the number of days, then press \boxed{n} .
2. Key in the annual interest rate, then press \boxed{i} .
3. Key in the principal amount, then press $\boxed{CHS}\boxed{PV}$.*
4. Press $\boxed{f}\boxed{INT}$ to calculate and display the interest accrued on a 360-day basis.
5. If you want to display the interest accrued on a 365-day basis, press $\boxed{R}\boxed{\downarrow}\boxed{x}\boxed{\Rightarrow}\boxed{y}$.
6. Press $\boxed{+}$ to calculate the total of the principal and the accrued interest now in the display.

The quantities n , i , and PV can be entered in any order.

Example 1: Your good friend needs a loan to start his latest enterprise and has requested that you lend him \$450 for 60 days. You lend him the money at 7% simple interest, to be calculated on a 360-day basis. What is the amount of accrued interest he will owe you in 60 days, and what is the total amount owed?

Keystrokes	Display	
60 \boxed{n}	60.00	Stores the number of days.

* Pressing the \boxed{PV} key stores the principal amount in the PV register, which then contains the *present value* of the amount on which interest will accrue. The \boxed{CHS} key is pressed first to change the sign of the principal amount before storing it in the PV register. This is required by the cash flow sign convention, which is applicable primarily to compound interest calculations.

34 Section 3: Basic Financial Functions

Keystrokes	Display	
7 <i>i</i>	7.00	Stores the annual interest rate.
450 <i>CHS</i> <i>PV</i>	-450.00	Stores the principal.
<i>f</i> <i>INT</i>	5.25	Accrued interest, 360-day basis.
<i>+</i>	455.25	Total amount: principal plus accrued interest.

Example 2: Your friend agrees to the 7% interest on the loan from the preceding example, but asks that you compute it on a 365-day basis rather than a 360-day basis. What is the amount of accrued interest he will owe you in 60 days, and what is the total amount owed?

Keystrokes	Display	
60 <i>n</i>	60.00	} If you have not altered the numbers in the n, i, and PV registers since the preceding example, you may skip these keystrokes.
7 <i>i</i>	7.00	
450 <i>CHS</i> <i>PV</i>	-450.00	
<i>f</i> <i>INT</i> <i>R↓</i> <i>×&#224;y</i>	5.18	Accrued interest, 365-day basis.
<i>+</i>	455.18	Total amount: principal plus accrued interest.

Financial Calculations and the Cash Flow Diagram

The concepts and examples presented in this section are representative of a wide range of financial calculations. If your specific problem does not appear to be illustrated in the pages that follow, *don't* assume that the calculator is not capable of solving it. Every financial calculation involves certain basic elements; but the terminology used to refer to these elements typically differs among the various segments of the business and financial communities. All you need to do is identify the basic elements in your problem, and then structure the problem so that it will be readily apparent what quantities you need to tell the calculator and what quantity you want to solve for.

An invaluable aid for using your calculator in a financial calculation is the *cash flow diagram*. This is simply a pictorial representation of the timing and direction of financial transactions, labeled in terms that correspond to keys on the calculator.

The diagram begins with a horizontal line, called a *time line*. It represents the duration of a financial problem, and is divided into compounding periods. For example, a financial problem that transpires over 6 months with monthly compounding would be diagrammed like this:



The exchange of money in a problem is depicted by vertical arrows. Money you receive is represented by an arrow pointing up from the point in the time line when the transaction occurs; money you pay out is represented by an arrow pointing down.

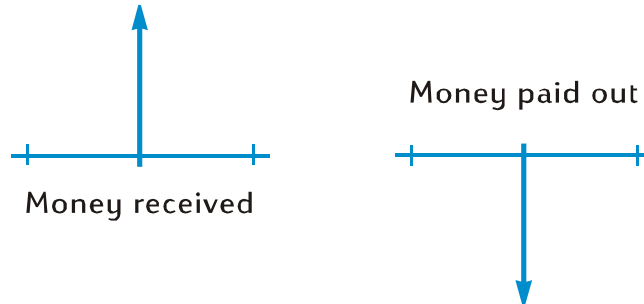

Suppose you deposited (paid out) \$1,000 into an account that pays 6% annual interest and is compounded monthly, and you subsequently deposited an additional \$50 at the end of each month for the next 2 years. The cash flow diagram describing the problem would look like this:

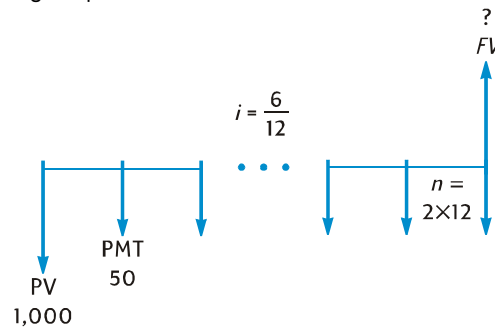

The arrow pointing up at the right of the diagram indicates that money is received at the end of the transaction. Every completed cash flow diagram must include at least one cash flow in each direction. Note that cash flows corresponding to the accrual of interest are *not* represented by arrows in the cash flow diagram.

The quantities in the problem that correspond to the first five keys on the top row of the keyboard are now readily apparent from the cash flow diagram.

- n is the number of compounding periods. This quantity can be expressed in years, months, days, or any other time unit, as long as the interest rate is expressed in terms of the same basic compounding period. In the problem illustrated in the cash flow diagram above, $n = 2 \times 12$.

36 Section 3: Basic Financial Functions

The form in which n is entered determines whether or not the calculator performs financial calculations in Odd-Period mode (as described on pages 50 through 53). If n is a *noninteger* (that is, there is at least one nonzero digit to the right of the decimal point), calculations of i , PV , PMT , and FV are performed in Odd-Period mode.

- i is the interest rate *per compounding period*. The interest rate shown in the cash flow diagram and entered into the calculator is determined by dividing the annual interest rate by the number of compounding periods. In the problem illustrated above, $i = 6\% \div 12$.
- PV — the *present value* — is the initial cash flow or the present value of a series of future cash flows. In the problem illustrated above, PV is the \$1,000 initial deposit.
- PMT is the period *payment*. In the problem illustrated above PMT is the \$50 deposited each month. When all payments are equal, they are referred to as *annuities*. (Problems involving equal payments are described in this section under Compound Interest Calculations; problems involving unequal payments can be handled as described in under Discounted Cash Flow Analysis: NPV and IRR. Procedures for calculating the balance in a savings account after a series of *irregular* and/or *unequal* deposits are included in the *hp 12c Solutions Handbook*.)
- FV — the *future value* — is the final cash flow or the compounded value of a series of prior cash flows. In the particular problem illustrated above, FV is unknown (but can be calculated).

Solving the problem is now basically a matter of keying in the quantities identified in the cash flow diagram using the corresponding keys, and then calculating the unknown quantity by pressing the corresponding key. In the particular problem illustrated in the cash flow diagram above, FV is the unknown quantity; but in other problems, as we shall see later, n , i , PV , or PMT could be the unknown quantity. Likewise, in the particular problem illustrated above there are four known quantities that must be entered into the calculator before solving for the unknown quantity; but in other problems only three quantities may be known — which must always include n or i .

The Cash Flow Sign Convention

When entering the PV , PMT , and FV cash flows, the quantities must be keyed into the calculator with the proper sign, + (plus) or – (minus), in accordance with ...

The Cash Flow Sign Convention: Money received (arrow pointing up) is entered or displayed as a positive value (+). Money paid out (arrow pointing down) is entered or displayed as a negative value (–).

The Payment Mode

One more bit of information must be specified before you can solve a problem involving periodic payments. Such payments can be made either at the beginning of a compounding period (payments in advance, or annuities due) or at the end of the period (payments in arrears, or ordinary annuities). Calculations involving payments in advance yield different results than calculations involving payments in arrears. Illustrated below are portions of cash flow diagrams showing payments in advance (Begin) and payments in arrears (End). In the problem illustrated in the cash flow diagram above, payments are made in arrears.



Regardless of whether payments are made in advance or in arrears, the number of payments must be the same as the number of compounding periods.

To specify the payment mode:

- Press **2nd** **BEG** if payments are made at the beginning of the compounding periods.
- Press **2nd** **END** if payments are made at the end of the compounding periods.

The **BEGIN** status indicator is lit when the payment mode is set to Begin. If **BEGIN** is not lit, the payment mode is set to End.

The payment mode remains set to what you last specified until you change it; it is not reset each time the calculator is turned on. However, if Continuous Memory is reset, the payment mode will be set to End.

Generalized Cash Flow Diagrams

Examples of various kinds of financial calculations, together with the applicable cash flow diagrams, appear under Compound Interest Calculations later in this section. If your particular problem does not match any of those shown, you can solve it nevertheless by first drawing a cash flow diagram, then keying the quantities identified in the diagram into the corresponding registers. *Remember always to observe the sign convention when keying in PV, PMT, and FV.*

The terminology used for describing financial problems varies among the different segments of the business and financial communities. Nevertheless, most problems involving compound interest can be solved by drawing a cash flow diagram in one of the following basic forms. Listed below each form are some of the problems to which that diagram applies.

38 Section 3: Basic Financial Functions

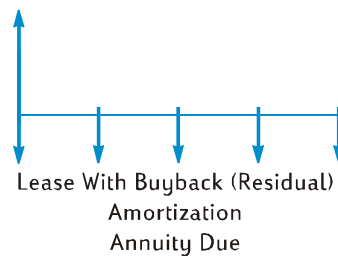
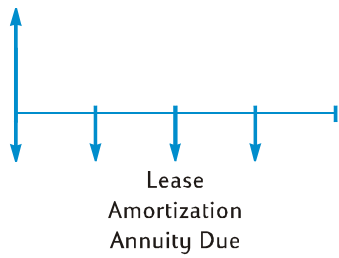
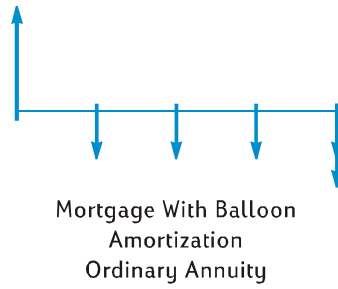
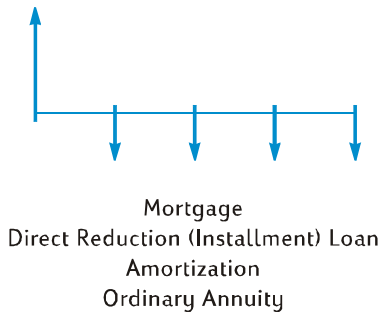
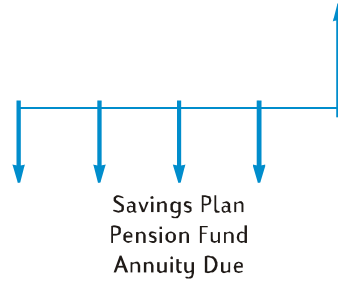
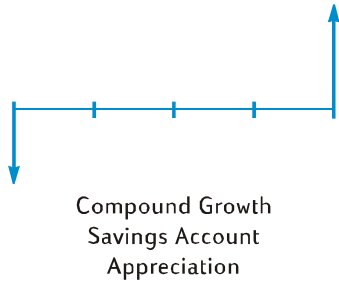

Compound Interest Calculations

Specifying the Number of Compounding Periods and the Periodic Interest Rate

Interest rates are usually quoted at the *annual rate* (also called the *nominal rate*): that is, the interest rate per year. However, in compound interest problems, the interest rate entered into *i* must always be expressed in terms of the basic compounding period, which may be years, months, days, or any other time unit. For example, if a problem involves 6% annual interest compounded quarterly for 5 years, *n* — the number of quarters — would be $5 \times 4 = 20$ and *i* — the interest rate per quarter — would be $6\% \div 4 = 1.5\%$. If the interest were instead compounded monthly, *n* would be $5 \times 12 = 60$ and *i* would be $6\% \div 12 = 0.5\%$.

If you use the calculator to multiply the number of years by the number of compounding periods per year, pressing \boxed{n} then stores the result into **n**. The same is true for **i**. Values of *n* and *i* are calculated and stored like this in Example 2 on page 47.

If interest is compounded monthly, you can use a shortcut provided on the calculator to calculate and store *n* and *i*:

- To calculate and store *n*, key the number of years into the display, then press $\boxed{g} \boxed{12x}$.
- To calculate and store *i*, key the annual rate into the display, then press $\boxed{g} \boxed{12\div}$.

Note that these keys not only multiply or divide the displayed number by 12; they also automatically store the result in the corresponding register, so you need not press the \boxed{n} or \boxed{i} key next. The $\boxed{12x}$ and $\boxed{12\div}$ keys are used in Example 1 on page 46.

Calculating the Number of Payments or Compounding Periods

1. Press $\boxed{f} \boxed{\text{CLEAR}} \boxed{\text{FIN}}$ to clear the financial registers.
2. Enter the periodic interest rate, using \boxed{i} or $\boxed{12\div}$.
3. Enter at least two of the following values:
 - Present value, using $\boxed{\text{PV}}$.
 - Payment amount, using $\boxed{\text{PMT}}$.
 - Future value, using $\boxed{\text{FV}}$.
4. If a *PMT* was entered, press $\boxed{g} \boxed{\text{BEG}}$ or $\boxed{g} \boxed{\text{END}}$ to set the payment mode.
5. Press \boxed{n} to calculate the number of payments or periods.

Note: Remember to observe the cash flow sign convention.

40 Section 3: Basic Financial Functions

If the answer calculated is not an integer (that is, there would be nonzero digits to the right of the decimal point), the calculator rounds the answer up to the next higher integer before storing it in the n register and displaying it.* For example, if n were calculated as 318.15, **319.00** would be the displayed answer.

n is rounded up by the calculator to show the *total* number of payments needed: $n-1$ equal, full payments, and one final, smaller payment. The calculator does not automatically adjust the values in the other financial registers to reflect n equal payments; rather, it allows you to choose which, if any, of the values to adjust.† Therefore, if you want to know the value of the final payment (with which you can calculate a balloon payment) or desire to know the payment value for n equal payments, you will need to press one of the other financial keys, as shown in the following two examples.

Example 1: You're planning to build a log cabin on your vacation property. Your rich uncle offers you a \$35,000 loan at 10.5% interest. If you make \$325 payments at the end of each month, how many payments will be required to pay off the loan, and how many years will this take?

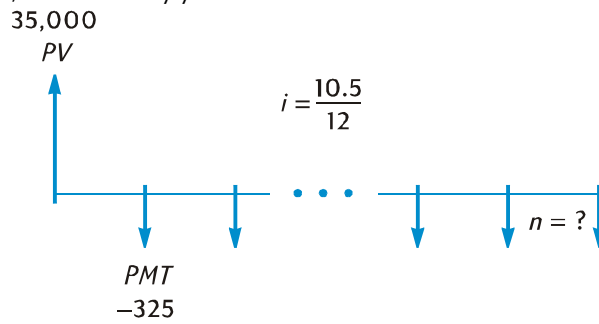

Keystrokes	Display	
\boxed{f} CLEAR \boxed{FIN}	0 . 88	Calculates and stores i .
10.5 \boxed{g} $\boxed{12 \div}$	35 , 000 . 00	Stores PV .
35000 \boxed{PV}	-325 . 00	Stores PMT (with minus sign for cash paid out).
325 \boxed{CHS} \boxed{PMT}	-325 . 00	Sets the payment mode to End.
\boxed{g} END	328 . 00	Number of payments required.
\boxed{n}		

* The calculator will round n down to the next lower integer if the fractional portion of n is less than 0.005.

† After calculating n , pressing \boxed{i} , \boxed{PV} , \boxed{PMT} , or \boxed{FV} will recalculate the value in the corresponding financial register.

Keystrokes	Display	
12 \div	27.33	Twenty-seven years and four months.

Because the calculator rounds the calculated value of n up to the next higher integer, in the preceding example it is likely that — while 328 payments will be required to pay off the loan — only 327 *full* payments of \$325 will be required, the next and final payment being less than \$325. You can calculate the final, fractional, 328th payment as follows:

Keystrokes	Display	
328 n	328.00	Stores total number of payments.*
FV	181.89	Calculates FV — which equals the overpayment if 328 full payments were made.
RCL PMT	-325.00	Recalls payment amount.
$+$	-143.11	Final, fractional payment.

Alternatively, you could make the fractional payment together with the 327th payment. (Doing so will result in a somewhat smaller total of all payments, since you will not have to pay interest during the 328th payment period.) You can calculate this final, larger, 327th payment (essentially a balloon payment) as follows:

Keystrokes	Display	
327 n	327.00	Stores number of <i>full</i> payments.
FV	-141.87	Calculates FV — which is the balance remaining after 327 full payments.
RCL PMT	-325.00	Recalls payment amount.
$+$	-466.87	Final, balloon payment.

Instead of having a fractional (or balloon) payment at the end of the loan, you might wish to make 327 or 328 *equal* payments. Refer to “Calculating the Payment Amount” on page 46 for a complete description of this procedure.

* You could skip this step, since 328 is already stored in the n register. If you do so, however, you will need to press FV twice in the next step (for the reason discussed in the first footnote on page 32; you would not have to press FV twice if you had not pressed 12 \div after n in the example above.) We choose to show this and the following example in a parallel format so that the procedure is easy to remember: the number you key is the number of the final payment — either the fractional payment or the balloon payment — whose amount is to be calculated.

42 Section 3: Basic Financial Functions

Example 2: You're opening a savings account today (the middle of the month) with a \$775 deposit. The account pays $6\frac{1}{4}\%$ interest compounded semimonthly. If you make semimonthly deposits of \$50 beginning next month, how long will it take for your account to reach \$4000?

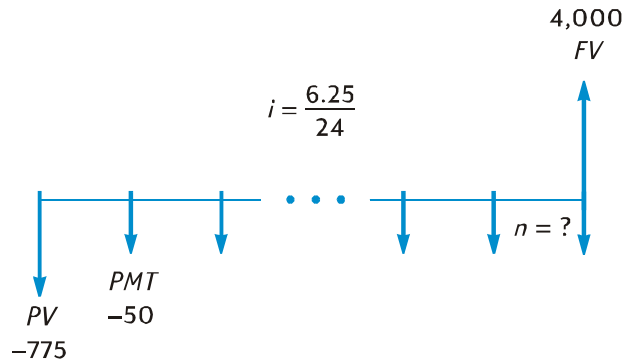

Keystrokes	Display	
\boxed{f} CLEAR \boxed{FIN}		
6.25 \boxed{ENTER} 24 $\boxed{\div}$ \boxed{i}	0.26	Calculates and stores i .
775 \boxed{CHS} \boxed{PV}	-775.00	Stores PV (with minus sign for cash paid out).
50 \boxed{CHS} \boxed{PMT}	-50.00	Stores PMT (with minus sign for cash paid out).
4000 \boxed{FV}	4,000.00	Stores FV .
\boxed{g} \boxed{END}	4,000.00	Sets the payment mode to End.
\boxed{n}	58.00	Number of semimonthly deposits.
2 $\boxed{\div}$	29.00	Number of months.

As in Example 1, it is likely that only 57 *full* deposits will be required, the next and final deposit being less than \$50. You can calculate this final, fractional, 58th deposit as in Example 1, except that for this example you must subtract the original FV . (In Example 1, the original FV was zero.) The procedure is as follows:

Keystrokes	Display	
$\boxed{\text{FV}} \boxed{\text{FV}}$	4,027.27	Calculates <i>FV</i> – which equals the balance in the account if 58 full deposits were made.*
$\boxed{\text{RCL}} \boxed{\text{PMT}}$	-50.00	Recalls amount of deposits.
$\boxed{+}$	3,977.27	Calculates the balance in the account if 57 full deposits were made and interest accrued during the 58 th month.†
4000 $\boxed{-}$	-22.73	Calculates final, fractional, 58 th deposit required to reach \$4,000.

Calculating the Periodic and Annual Interest Rates

1. Press $\boxed{\text{f}} \boxed{\text{CLEAR}} \boxed{\text{FIN}}$ to clear the financial registers.
 2. Enter the number of payments or periods, using \boxed{n} or $\boxed{12X}$.
 3. Enter at least two of the following values:
 - Present value, using $\boxed{\text{PV}}$.
 - Payment amount, using $\boxed{\text{PMT}}$.
 - Future value, using $\boxed{\text{FV}}$.
- } **Note:** Remember to observe the cash flow sign convention.
4. If a *PMT* was entered, press $\boxed{9} \boxed{\text{BEG}}$ or $\boxed{9} \boxed{\text{END}}$ to set the payment mode.
 5. Press \boxed{i} to calculate the periodic interest rate.
 6. To calculate the annual interest rate, key in the number of periods per year, then press \boxed{X} .

* In this example, $\boxed{\text{FV}}$ must be pressed twice, since the preceding key pressed was $\boxed{+}$. If we had stored the number of deposits in *n* (as we did following Example 1), we would have to press $\boxed{\text{FV}}$ only once here, since the preceding key pressed would have been \boxed{n} (as it was following Example 1). Remember that it is not necessary to store the number of payments in *n* before calculating the amount of the final, *fractional* payment. (Refer to the preceding footnote.)

† You might think that we could calculate the balance in the account after 57 *full* deposits were made simply by storing that number in *n* and then calculating *FV*, as we did using the second method following Example 1. However, this balance would *not* include the interest accrued during the 58th month.

44 Section 3: Basic Financial Functions

Example: What annual interest rate must be obtained to accumulate \$10,000 in 8 years on an investment of \$6,000 with quarterly compounding?

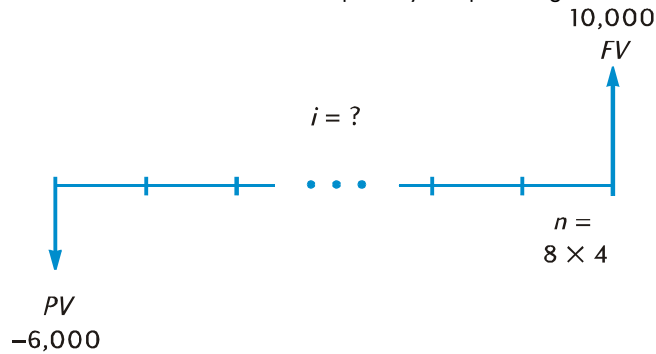

Keystrokes

\boxed{f} CLEAR \boxed{FIN}

8 \boxed{ENTER} 4 \boxed{X} \boxed{n}

6000 \boxed{CHS} \boxed{PV}

10000 \boxed{FV}

\boxed{i}

4 \boxed{X}

Display

32.00

Calculates and stores n .

-6,000.00

Stores PV (with minus sign for cash paid out).

10,000.00

Stores FV .

1.61

Periodic (quarterly) interest rate.

6.44

Annual interest rate.

Calculating the Present Value

1. Press \boxed{f} CLEAR \boxed{FIN} to clear the financial registers.
 2. Enter the number of payments or periods, using \boxed{n} or $\boxed{12X}$.
 3. Enter the periodic interest rate, using \boxed{i} or $\boxed{12\div}$.
 4. Enter either or both of the following:
 - Payment amount, using \boxed{PMT} .
 - Future value, using \boxed{FV} .
- Note:** Remember to observe the cash flow sign convention.
5. If a PMT was entered, press $\boxed{9}$ \boxed{BEG} or $\boxed{9}$ \boxed{END} to set the payment mode.
 6. Press \boxed{PV} to calculate the present value.

Example 1: You're financing a new car purchase with a loan from an institution that requires 15% interest compounded monthly over the 4-year term of the loan. If you can make payments of \$150 at the end of each month and your down payment will be \$1,500, what is the maximum price you can pay for the car? (Assume the purchase date is one month prior to the date of the first payment.)

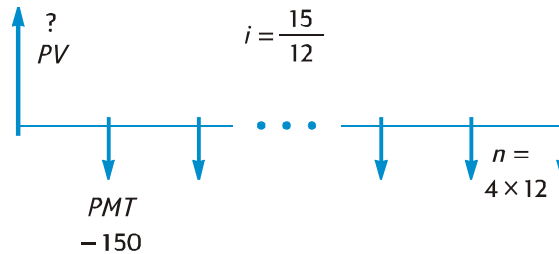

Keystrokes

Display

<code>f</code> <code>CLEAR</code> <code>FIN</code>	48.00	Calculates and stores n .
4 <code>g</code> <code>12x</code>	1.25	Calculates and stores i .
15 <code>g</code> <code>12÷</code>	-150.00	Stores PMT (with minus sign for cash paid out).
150 <code>CHS</code> <code>PMT</code>	-150.00	Sets payment mode to End.
<code>g</code> <code>END</code>	5,389.72	Maximum amount of loan.
<code>PV</code>	6,889.72	Maximum purchase price.
1500 <code>+</code>		

Example 2: A development company would like to purchase a group of condominiums with an annual net cash flow of \$17,500. The expected holding period is 5 years, and the estimated selling price at that time is \$540,000. Calculate the maximum amount the company can pay for the condominiums in order to realize at least a 12% annual yield.

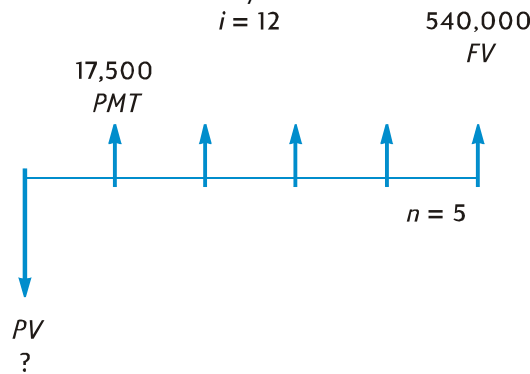

46 Section 3: Basic Financial Functions

Keystrokes	Display	
\boxed{f} CLEAR \boxed{FIN}		
5 \boxed{n}	5.00	Stores n .
12 \boxed{i}	12.00	Stores i .
17500 \boxed{PMT}	17,500.00	Stores PMT . Unlike in the previous problem, here PMT is positive since it represents cash <i>received</i> .
540000 \boxed{FV}	540,000.00	Stores FV .
\boxed{g} \boxed{END}	540,000.00	Sets payment mode to End.
\boxed{PV}	-369,494.09	The maximum purchase price to provide a 12% annual yield. PV is displayed with a minus sign since it represents cash <i>paid out</i> .

Calculating the Payment Amount

- Press \boxed{f} CLEAR \boxed{FIN} to clear the financial registers.
 - Enter the number of payments or periods, using \boxed{n} or $\boxed{12X}$.
 - Enter the periodic interest rate, using \boxed{i} or $\boxed{12\div}$.
 - Enter either or both of the following:
 - Present value, using \boxed{PV} .
 - Future value, using \boxed{FV} .
- } **Note:** Remember to observe the cash flow sign convention.
- Press \boxed{g} \boxed{BEG} or \boxed{g} \boxed{END} to set the payment mode.
 - Press \boxed{PMT} to calculate the payment amount.

Example 1: Calculate the payment amount on a 29-year, \$43,400 mortgage at $14\frac{1}{4}\%$ annual interest.

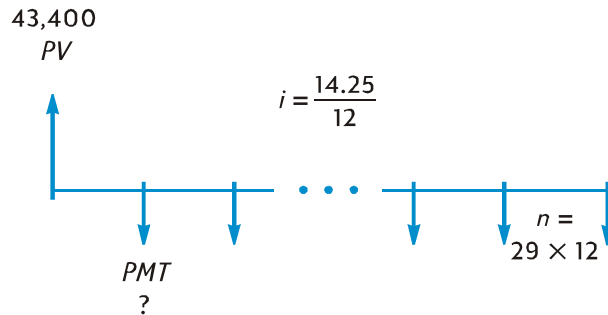

Keystrokes	Display	
\boxed{f} $\boxed{\text{CLEAR}}$ $\boxed{\text{FIN}}$	348.00	Calculates and stores n .
29 \boxed{g} $\boxed{12}$ \boxed{x}	1.19	Calculates and stores i .
14.25 \boxed{g} $\boxed{12}$ $\boxed{\div}$	43,400.00	Stores PV .
43400 \boxed{PV}	43,400.00	Sets payment mode to End.
\boxed{g} $\boxed{\text{END}}$	-523.99	Monthly payment (with minus sign for cash paid out).
$\boxed{\text{PMT}}$		

Example 2: Looking forward to retirement, you wish to accumulate \$60,000 after 15 years by making deposits in an account that pays $9\frac{3}{4}\%$ interest compounded semiannually. You open the account with a deposit of \$3,200 and intend to make semiannual deposits, beginning six months later, from your profit-sharing bonus paychecks. Calculate how much these deposits should be.

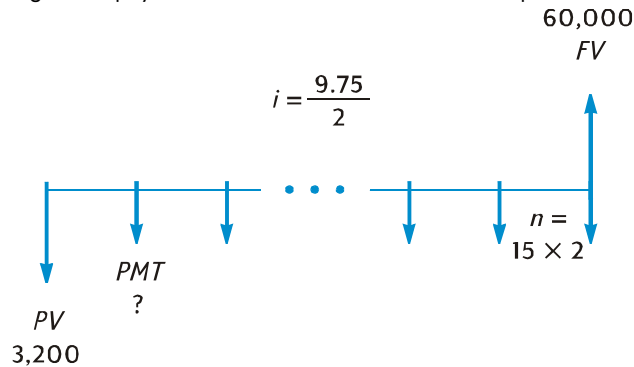

Keystrokes	Display	
\boxed{f} $\boxed{\text{CLEAR}}$ $\boxed{\text{FIN}}$	30.00	Calculates and stores n .
15 $\boxed{\text{ENTER}}$ $\boxed{2}$ \boxed{x} \boxed{n}	4.88	Calculates and stores i .
9.75 $\boxed{\text{ENTER}}$ $\boxed{2}$ $\boxed{\div}$ \boxed{i}	-3200.00	Stores PV (with minus sign for cash paid out).
3200 $\boxed{\text{CHS}}$ \boxed{PV}	60,000.00	Stores FV .
60000 \boxed{FV}	60,000.00	Sets payment mode to End.
\boxed{g} $\boxed{\text{END}}$	-717.44	Semiannual payment (with minus sign for cash paid out).
$\boxed{\text{PMT}}$		

48 Section 3: Basic Financial Functions

Calculating the Future Value

1. Press \boxed{f} CLEAR \boxed{FIN} to clear the financial registers.
 2. Enter the number of payments or periods, using \boxed{n} or $\boxed{12X}$.
 3. Enter the periodic interest rate, using \boxed{i} or $\boxed{12\div}$.
 4. Enter either or both of the following:
 - Present value, using \boxed{PV} .
 - Payment amount, using \boxed{PMT} .
- Note:** Remember to observe the cash flow sign convention.
5. If a *PMT* was entered, press \boxed{g} \boxed{BEG} or \boxed{g} \boxed{END} to set the payment mode.
 6. Press \boxed{FV} to calculate the future value.

Example 1: In Example 1 on page 46, we calculated that the payment amount on a 29-year, \$43,400 mortgage at $14\frac{1}{4}\%$ annual interest is \$523.99. If the seller requests a balloon payment at the end of 5 years, what would be the amount of the balloon?

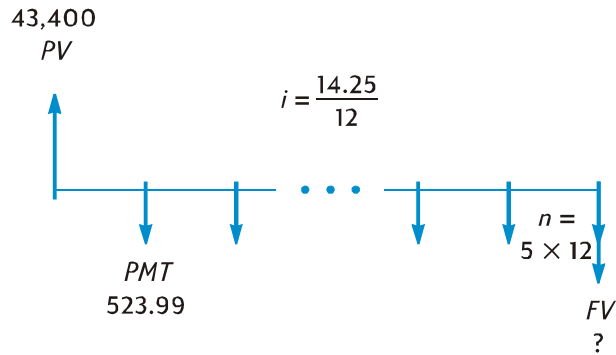

Keystrokes

\boxed{f} CLEAR \boxed{FIN}
 5 \boxed{g} $\boxed{12X}$
 14.25 \boxed{g} $\boxed{12\div}$
 43400 \boxed{PV}
 523.99 \boxed{CHS} \boxed{PMT}

 \boxed{g} \boxed{END}
 \boxed{FV}

Display

60.00 Calculates and stores *n*.
 1.19 Calculates and stores *i*.
 $43,400.00$ Stores *PV*.
 -523.99 Stores *PMT* (with minus sign for cash paid out).
 -523.99 Sets payment mode to End.
 $-42,652.37$ Amount of balloon payment.

Example 2: If you deposit \$50 a month (at the beginning of each month) into a new account that pays $6\frac{1}{4}\%$ annual interest compounded monthly, how much will you have in the account after 2 years?

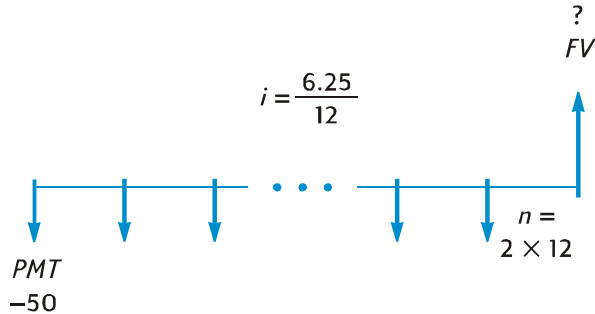

Keystrokes	Display	
\boxed{f} CLEAR \boxed{FIN}		
2 \boxed{g} $\boxed{12x}$	24.00	Calculates and stores n .
6.25 \boxed{g} $\boxed{12\div}$	0.52	Calculates and stores i .
50 \boxed{CHS} \boxed{PMT}	-50.00	Stores PMT (with minus sign for cash paid out).
\boxed{g} \boxed{BEG}	-50.00	Sets payment mode to Begin.
\boxed{FV}	1,281.34	Balance after 2 years.

Example 3: Property values in an unattractive area are depreciating at the rate of 2% per year. Assuming this trend continues, calculate the value in 6 years of property presently appraised at \$32,000.

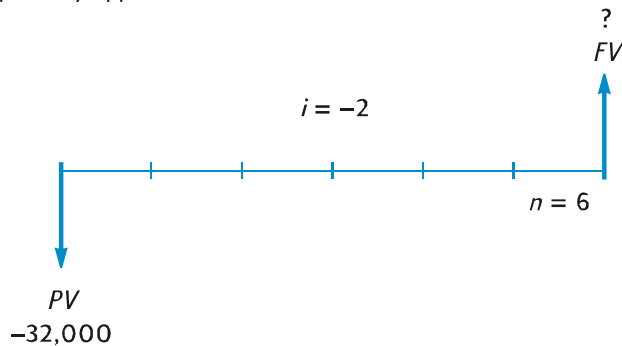

Keystrokes	Display	
\boxed{f} CLEAR \boxed{FIN}		
6 \boxed{n}	6.00	Stores n .

50 Section 3: Basic Financial Functions

Keystrokes	Display	
2 [CHS] [i]	-2.00	Stores i (with minus sign for a "negative interest rate").
32000 [CHS] [PV]	-32,000.00	Stores PV (with minus sign for cash paid out).
[FV]	28,346.96	Property value after 6 years.

Odd-Period Calculations

The cash flow diagrams and examples presented so far have dealt with financial transactions in which interest begins to accrue at the beginning of the first regular payment period. However, interest often begins to accrue prior to the beginning of the first regular payment period. The period from the date interest begins accruing to the date of the first payment, being not equal to the regular payment periods is sometimes referred to as an "odd first period". For simplicity, in using the hp 12c we will always regard the first period as equal to the remaining periods, and we will refer to the *period between the date interest begins accruing and the beginning of the first payment period* as simply the "odd period" or the "odd days". (Note that the odd period is always assumed by the calculator to occur before the first full payment period.) The following two cash flow diagrams represent transactions including an odd period for payments in advance (Begin) and for payments in arrears (End).

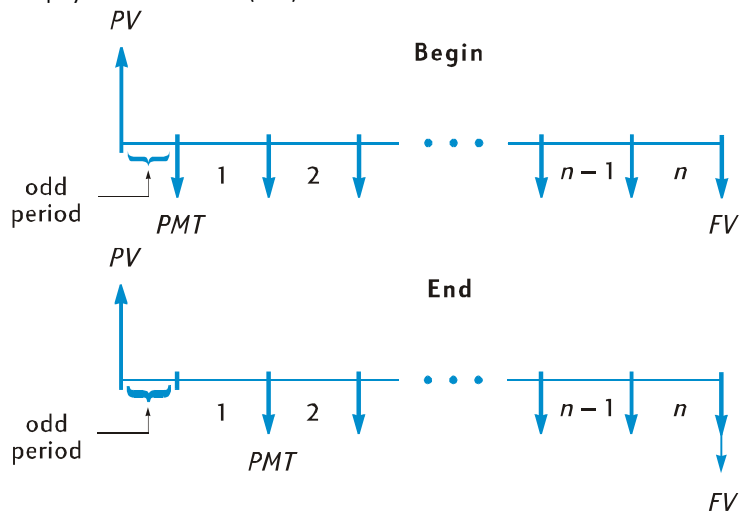

You can calculate i , PV , PMT , and FV for transactions involving an odd period simply by entering a *noninteger* n . (A noninteger is a number with at least one nonzero digit to the right of the decimal point.) This places the calculator in Odd-Period mode.* The integer part of n (the part to the left of the decimal point) specifies the number of full payment periods, and the fractional part (the part to the right of the decimal) specifies the length of the odd period as a fraction of a full period. The odd period, therefore, cannot be greater than one full period.

The fractional part of n can be determined using either the actual number of odd days or the number of odd days counted on the basis of a 30-day month.† The ΔDYS function can be used to calculate the number of odd days either way. The fractional part of n is a fraction of a payment period, so the number of odd days must be divided by the number of days in a period. If interest is compounded monthly, for this number you can use either 30, $365/12$, or (if the odd period falls entirely within a single month) the actual number of days in that month. Usually, a monthly period is taken to be 30 days long.

At your option, the calculations of i , PV , PMT , and FV can be performed with either simple interest or compound interest accruing during the odd period. If the **C** status indicator in the display is not lit, simple interest is used. To specify compound interest, turn the **C** indicator on by pressing STO|EEX .‡ Pressing STO|EEX again turns the **C** indicator off, and calculations will then be performed using simple interest for the odd period.

* Calculations of i , PMT , and FV are performed using the present value at the end of the odd period. This is equal to the number in the PV register *plus* the interest accrued during the odd period. When calculating PV in Odd-Period mode, the calculator returns a value equal to the present value at the *beginning* of the odd period and stores it in the PV register.

After calculating i , PV , PMT , or FV in Odd-Period mode, you should not try to calculate n . If you do, the calculator will switch out of Odd-Period mode and compute n without taking the odd period into account. The values in the other financial registers will correspond to the new n , but the original assumptions for the problem will be changed.

† The two methods of counting odd days will yield slightly different answers. If you are calculating i to determine the annual percentage rate (APR) for an odd-period transaction, the lower APR will result if the calculation uses the greater number of odd days determined using the two methods.

‡ STO|EEX is not programmable.

52 Section 3: Basic Financial Functions

Example 1: A 36-month loan for \$4,500 accrues interest at a 15% annual percentage rate (APR), with the payments made at the end of each month. If interest begins accruing on this loan on February 15, 2004 (so that the first period begins on March 1, 2004), calculate the monthly payment, with the odd days counted on the basis of a 30-day month and compound interest used for the odd period.

Keystrokes	Display	
f CLEAR FIN		Clears financial registers.
g M.DY		Sets date format to month-day-year.
g END		Sets payment mode to End.
STO EEX		Turns on the C indicator in the display, so that compound interest will be used for the odd period.
2.152004 ENTER	2.15	Keys in the date interest begins accruing and separates it from the next date entered.
3.012004	3.012004	Keys in the date of the beginning of the first period.
g ADYS	15.00	Actual number of odd days.
x y	16.00	Number of odd days counted on the basis of a 30-day month.
30 ÷	0.53	Divides by the length of a monthly period to get the fractional part of n .
36 + n	36.53	Adds the fractional part of n to the number of complete payment periods, then stores the result in n .
15 g 12 ÷	1.25	Calculates and stores i .
4500 PV	4,500.00	Stores PV .
PMT	-157.03	Monthly payment.

Example 2: A 42-month car loan for \$3,950 began accruing interest on July 19, 2004, so that the first period began on August 1, 2004. Payments of \$120 are made at the end of each month. Calculate the annual percentage rate (APR), using the actual number of odd days and simple interest for the odd period.

Keystrokes	Display	
\boxed{f} $\boxed{\text{CLEAR}}$ $\boxed{\text{FIN}}$		Clears financial registers.
$\boxed{\text{STO}}$ $\boxed{\text{EEX}}$		Turns off the C indicator in the display, so that simple interest will be used for the odd period.
7.192004 $\boxed{\text{ENTER}}$	7.19	Keys in the date interest begins accruing and separates it from the next date entered.
8.012004	8.012004	Keys in the date of the beginning of the first period.
\boxed{g} $\boxed{\Delta\text{DYS}}$	13.00	Actual number of odd days.
30 $\boxed{\div}$	0.43	Divides by the length of a monthly period to get the fractional part of n .
42 $\boxed{+}$ \boxed{n}	42.43	Adds the fractional part of n to the number of complete payment periods, then stores the result in n .
3950 $\boxed{\text{PV}}$	3,950.00	Stores PV .
120 $\boxed{\text{CHS}}$ $\boxed{\text{PMT}}$	-120.00	Stores PMT (with minus sign for cash paid out).
\boxed{i}	1.16	Periodic (monthly) interest rate.
12 $\boxed{\text{X}}$	13.95	Annual percentage rate (APR).

54 Section 3: Basic Financial Functions

Amortization

The hp 12c enables you to calculate the amounts applied toward principal and toward interest from a single loan payment or from several payments, and also tells you the remaining balance of the loan after the payments are made.*

To obtain an amortization schedule:

1. Press \boxed{f} CLEAR \boxed{FIN} to clear the financial registers.
2. Enter the periodic interest rate, using \boxed{i} or $\boxed{12\div}$.
3. Enter the amount of the loan (the principal), using \boxed{PV} .
4. Key in the periodic payment, then press \boxed{CHS} \boxed{PMT} (the sign of *PMT* must be negative, in accordance with the cash flow sign convention).
5. Press \boxed{g} \boxed{BEG} or (for most direct reduction loans) \boxed{g} \boxed{END} to set the payment mode.
6. Key in the number of payments to be amortized.
7. Press \boxed{f} \boxed{AMORT} to display the amount from those payments applied toward interest.
8. Press $\boxed{x\rightleftharpoons y}$ to display the amount from those payments applied toward the principal.
9. To display the number of payments just amortized, press $\boxed{R\downarrow}$ $\boxed{R\downarrow}$.
10. To display the remaining balance of the loan, press \boxed{RCL} \boxed{PV} .
11. To display the *total* number of payments amortized, press \boxed{RCL} \boxed{n} .

Example: For a house you're about to buy, you can obtain a 25-year mortgage for \$50,000 at $13\frac{1}{4}\%$ annual interest. This requires payments of \$573.35 (at the end of each month). Find the amounts that would be applied to interest and to the principal from the first year's payments.

Keystrokes	Display
\boxed{f} CLEAR \boxed{FIN}	
13.25 \boxed{g} $\boxed{12\div}$	1 . 10 Enters <i>i</i> .
50000 \boxed{PV}	50 , 000 . 00 Enters <i>PV</i> .

* All amounts calculated when \boxed{f} \boxed{AMORT} is pressed are automatically rounded to the number of decimal places specified by the display format. (The display format is described in Section 5.) This rounding affects the number *inside* the calculator as well as how the number appears in the display. The amounts calculated on your hp 12c may differ from those on the statements of lending institutions by a few cents, since different rounding techniques are sometimes used. To calculate answers rounded to a different number of decimal places, press \boxed{f} followed by the number of decimal places desired before you press \boxed{f} \boxed{AMORT} .

Keystrokes	Display	
573.35 [CHS] [PMT]	-573.35	Enters <i>PMT</i> (with minus sign for cash paid out).
[g] [END]	-573.35	Sets payment mode to End.
12 [f] [AMORT]	-6,608.89	Portion of first year's payments (12 months) applied to interest.
[x≐y]	-271.31	Portion of first year's payments applied to principal.
[RCL] [PV]	49,728.69	Balance remaining after 1 year.
[RCL] [n]	12.00	Total number of payments amortized.

The number of payments keyed in just before [f] [AMORT] is pressed is taken to be the payments following any that have already been amortized. Thus, if you now press 12 [f] [AMORT], your hp 12c will calculate the amounts applied to interest and to the principal from the second year's payments (that is, the second 12 months):

Keystrokes	Display	
12 [f] [AMORT]	-6,570.72	Portion of second year's payments applied to interest.
[x≐y]	-309.48	Portion of second year's payments applied to principal.
[R↓] [R↓]	12.00	Number of payments just amortized.
[RCL] [PV]	49,419.21	Balance remaining after 2 years.
[RCL] [n]	24.00	Total number of payments amortized.

Pressing [RCL] [PV] or [RCL] [n] displays the number in the PV or n register. When you did so after each of the last two calculations, you may have noticed that *PV* and *n* had been changed from their original values. The calculator does this so that you can easily check the remaining balance and the total number of payments amortized. But because of this, if you want to generate a new amortization schedule from the beginning, you must reset *PV* to its original value and reset *n* to 0.

For example, suppose you now wanted to generate an amortization schedule for each of the first two months:

Keystrokes	Display	
50000 [PV]	50,000.00	Resets <i>PV</i> to original value.
0 [n]	0.00	Resets <i>n</i> to zero.

56 Section 3: Basic Financial Functions

Keystrokes	Display	
1 \boxed{f} \boxed{AMORT}	-552.08	Portion of first payment applied to interest.
$\boxed{X} \boxed{\div} \boxed{Y}$	-21.27	Portion of first payment applied to principal.
1 \boxed{f} \boxed{AMORT}	-551.85	Portion of second payment applied to interest.
$\boxed{X} \boxed{\div} \boxed{Y}$	-21.50	Portion of second payment applied to principal.
$\boxed{RCL} \boxed{n}$	2.00	Total number of payments amortized.

If you want to generate an amortization schedule but do not already know the monthly payment:

1. Calculate *PMT* as described on page 46.
2. Press $0 \boxed{n}$ to reset *n* to zero.
3. Proceed with the amortization procedure listed on page 54 beginning with step 6.

Example: Suppose you obtained a 30-year mortgage instead of a 25-year mortgage for the same principal (\$50,000) and at the same interest rate ($13\frac{1}{4}\%$) as in the preceding example. Calculate the monthly payment, then calculate the amounts applied to interest and to the principal from the first month's payment. Since the interest rate is not being changed, do not press $\boxed{f} \boxed{CLEAR} \boxed{FIN}$; to calculate *PMT*, just enter the new value for *n*, reset *PV*, then press \boxed{PMT} .

Keystrokes	Display	
30 \boxed{g} $\boxed{12X}$	360.00	Enters <i>n</i> .
50000 \boxed{PV}	50,000.00	Enters <i>PV</i> .
\boxed{PMT}	-562.89	Monthly payment.
0 \boxed{n}	0.00	Resets <i>n</i> to zero.
1 \boxed{f} \boxed{AMORT}	-552.08	Portion of first payment applied to interest.
$\boxed{X} \boxed{\div} \boxed{Y}$	-10.81	Portion of first payment applied to principal.
$\boxed{RCL} \boxed{PV}$	49,989.19	Remaining balance.

Section 4

Additional Financial Functions

Discounted Cash Flow Analysis: NPV and IRR

The hp 12c provides functions for the two most widely-used methods of discounted cash flow analysis: **NPV** (*net present value*) and **IRR** (*internal rate of return*). These functions enable you to analyze financial problems involving cash flows (money paid out or received) occurring at regular intervals. As in compound interest calculations, the interval between cash flows can be any time period; however, the amounts of these cash flows need not be equal.

To understand how to use **NPV** and **IRR**, let's consider the cash flow diagram for an investment that requires an initial cash outlay (CF_0) and generates a cash flow (CF_1) at the end of the first year, and so on up to the final cash flow (CF_6) at the end of the sixth year. In the following diagram, the initial investment is denoted by CF_0 , and is depicted as an arrow pointing down from the time line since it is cash paid out. Cash flows CF_1 and CF_4 also point down from the time line, because they represent projected cash flow losses.

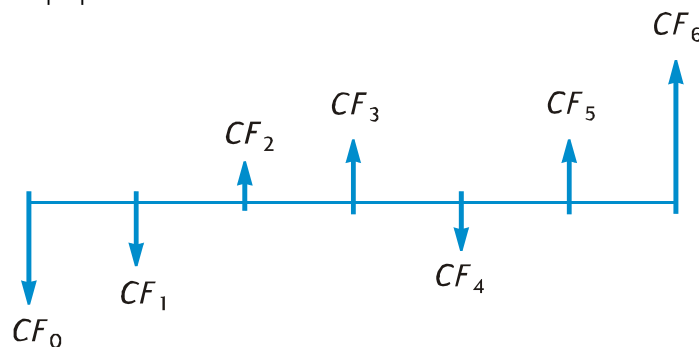

NPV is calculated by adding the initial investment (represented as a *negative* cash flow) to the present value of the anticipated future cash flows. The interest rate, i , will be referred to in this discussion of **NPV** and **IRR** as the *rate of return*.* The value of **NPV** indicates the result of the investment:

* Other terms are sometimes used to refer to the rate of return. These include: *required rate of return*, *minimally acceptable rate of return*, and *cost of capital*.

58 Section 4: Additional Financial Functions

- If *NPV* is positive, the financial value of the investor's assets would be increased: the investment is financially attractive.
- If *NPV* is zero, the financial value of the investor's assets would not change: the investor is indifferent toward the investment.
- If *NPV* is negative, the financial value of the investor's assets would be decreased: the investment is not financially attractive.

A comparison of the *NPV*'s of alternative investment possibilities indicates which of them is most desirable: the greater the *NPV*, the greater the increase in the financial value of the investor's assets.

IRR is the rate of return at which the discounted future cash flows equal the initial cash outlay: *IRR* is the discount rate at which *NPV* is zero. The value of *IRR* relative to the present value discount rate also indicates the result of the investment:

- If *IRR* is greater than the desired rate of return, the investment is financially attractive.
- If *IRR* is equal to the desired rate of return, the investor is indifferent toward the investment.
- If *IRR* is less than the desired rate of return, the investment is not financially attractive.

Calculating Net Present Value (NPV)

Calculating NPV for Ungrouped Cash Flows. If there are no equal consecutive cash flows, use the procedure described (and then summarized) below. With this procedure, *NPV* (and *IRR*) problems involving up to 20 cash flows (in addition to the initial investment CF_0) can be solved. If two or more consecutive cash flows are equal — for example, if the cash flows in periods three and four are both \$8,500 — you can solve problems involving more than 20 cash flows, or you can minimize the number of storage registers required for problems involving less than 20 cash flows, by using the procedure described next (under Calculating *NPV* for Grouped Cash Flows, page 61).

The amount of the initial investment (CF_0) is entered into the calculator using the $\boxed{CF_0}$ key. Pressing $\boxed{g}\boxed{CF_0}$ stores CF_0 in storage register R_0 and also stores the number 0 in the *n* register.

The amounts of the subsequent cash flows are stored – in the order they occur – in the remaining storage registers: CF_1 thru CF_9 in R_1 thru R_9 , and CF_{10} thru CF_{19} in R_{10} thru R_{19} , respectively. If there is a CF_{20} , that amount is stored in the FV register.*

Each cash flow (CF_1 , CF_2 , etc.) is designated CF_j , where j takes on values from 1 up to the number of the final cash flow. The amount of a cash flow is entered using the \boxed{CFj} key. Each time $\boxed{g}\boxed{CFj}$ is pressed, the amount in the display is stored in the next available storage register, and the number in the n register is increased by 1. This register therefore counts how many cash flow amounts (in addition to the initial investment CF_0) have been entered.

Note: When entering cash flow amounts — including the initial investment CF_0 — remember to observe the cash flow sign convention by pressing \boxed{CHS} after keying in a negative cash flow.

In summary, to enter the cash flow amounts:

1. Press $\boxed{f}\boxed{CLEAR}\boxed{REG}$ to clear the financial and storage registers.
2. Key in the amount of the initial investment, press \boxed{CHS} if that cash flow is negative, then press $\boxed{g}\boxed{CF0}$. If there is no initial investment, press $0\boxed{g}\boxed{CF0}$.
3. Key in the amount of the next cash flow, press \boxed{CHS} if the cash flow is negative, then press $\boxed{g}\boxed{CFj}$. If the cash flow amount is zero in the next period, press $0\boxed{g}\boxed{CFj}$.
4. Repeat step 3 for each cash flow until all have been entered.

With the amounts of the cash flows stored in the calculator's registers, you can calculate NPV as follows:

1. Enter the interest rate, using \boxed{i} or $\boxed{12}\boxed{\div}$.
2. Press $\boxed{f}\boxed{NPV}$.

The calculated value of NPV appears in the display and also is automatically stored in the PV register.

* If you have stored a program in the calculator, the number of registers available for storing cash flow amounts may be less than 21. (Storage registers are automatically allocated to program lines beginning with R_9 and proceeding in reverse order to R_1 , as described on pages 93 thru 95.) The maximum number of cash flow amounts (in addition to CF_0) that can be stored is the number that appears at the right of the display when $\boxed{g}\boxed{MEM}$ is pressed. If the maximum number of cash flow amounts is stored, the final cash flow amount is always stored in the FV register. For example, if \boxed{MEM} displays **P-08 r-20**, the last cash flow amount that can be stored – CF_{20} – will be stored in FV. Similarly, if \boxed{MEM} displays **P-22 r-18**, the last cash flow amount that can be stored – CF_{18} – will be stored in FV.

60 Section 4: Additional Financial Functions

Example: An investor has an opportunity to buy a duplex for \$80,000 and would like a return of at least 13%. He expects to keep the duplex 5 years and then sell it for \$130,000; and he anticipates the cash flows shown in the diagram below. Calculate NPV to determine whether the investment would result in a return or a loss.

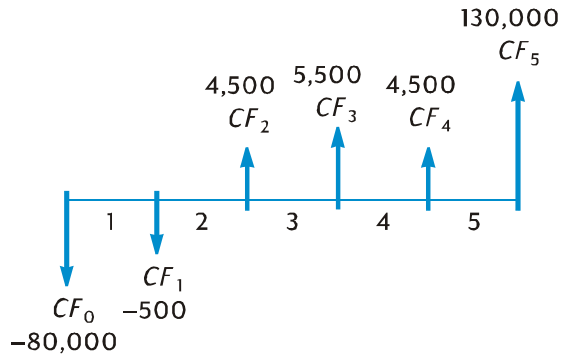

Note that although a cash flow amount (\$4,500) occurs twice, these cash flows are *not* consecutive. Therefore, these cash flows must be entered using the method described above.

Keystrokes	Display	Description
<code>f</code> <code>CLEAR</code> <code>REG</code>	0 . 00	Clears financial and storage registers.
80000 <code>CHS</code> <code>g</code> <code>CF0</code>	-80 , 000 . 00	Stores CF_0 (with minus sign for a negative cash flow).
500 <code>CHS</code> <code>g</code> <code>CF1</code>	-500 . 00	Stores CF_1 (with minus sign for a negative cash flow).
4500 <code>g</code> <code>CF1</code>	4 , 500 . 00	Stores CF_2 .
5500 <code>g</code> <code>CF1</code>	5 , 500 . 00	Stores CF_3 .
4500 <code>g</code> <code>CF1</code>	4 , 500 . 00	Stores CF_4 .
130000 <code>g</code> <code>CF1</code>	130 , 000 . 00	Stores CF_5 .
<code>RCL</code> <code>n</code>	5 . 00	Checks number of cash flow amounts entered (in addition to CF_0).
13 <code>i</code>	13 . 00	Stores i .
<code>f</code> <code>NPV</code>	212 . 18	NPV.

Since NPV is positive, the investment would increase the financial value of the investor's assets.

Calculating NPV for Grouped Cash Flows. A maximum of 20 cash flow amounts (in addition to the initial investment CF_0) can be stored in the hp 12c.* However, problems involving more than 20 cash flows can be handled if among the cash flows there are *equal consecutive* cash flows. For such problems, you merely enter along with the amounts of the cash flows the number of times — up to 99 — each amount occurs consecutively. This number is designated N_i , corresponding to cash flow amount CF_i , and is entered using the $\boxed{N_i}$ key. Each N_i is stored in a special register inside the calculator.

This method can, of course, be used for problems involving fewer than 20 cash flows — and it will require fewer storage registers than the method described above under Calculating NPV for Ungrouped Cash Flows. Equal consecutive cash flows can be entered using that method — provided there are enough storage registers available to accommodate the total number of individual cash flows. The facility of grouping equal consecutive cash flows is provided to minimize the number of storage registers required.

Note: When entering cash flow amounts — including the initial investment CF_0 — remember to observe the cash flow sign convention by pressing \boxed{CHS} after keying in the amount for a negative cash flow.

In summary, to enter the amounts of the cash flows and the number of times they occur consecutively:

1. Press $\boxed{f}\boxed{CLEAR}\boxed{REG}$ to clear the financial and storage registers.
2. Key in the amount of the initial investment, press \boxed{CHS} if that cash flow is negative, then press $\boxed{g}\boxed{CF_0}$. If there is no initial investment, press $0\boxed{g}\boxed{CF_0}$.
3. If the initial investment consists of more than one cash flow of the amount entered in step 2, key in the number of those cash flows, then press $\boxed{g}\boxed{N_i}$. If $\boxed{g}\boxed{N_i}$ is not pressed, the calculator assumes that N_0 is 1.
4. Key in the amount of the next cash flow, press \boxed{CHS} if that cash flow is negative, then press $\boxed{g}\boxed{CF_1}$. If the cash flow amount is zero in the next period, press $0\boxed{g}\boxed{CF_1}$.
5. If the amount entered in step 4 occurs more than once consecutively, key in the number of times that cash flow amount occurs consecutively, then press $\boxed{g}\boxed{N_i}$. If $\boxed{g}\boxed{N_i}$ is not pressed, the calculator assumes that N_i is 1 for the CF_i just entered.
6. Repeat steps 4 and 5 for each CF_i and N_i until all cash flows have been entered.

With the amounts of the cash flows and the number of times they occur consecutively stored in the calculator, NPV can be calculated by entering the interest rate and pressing $\boxed{f}\boxed{NPV}$, just as described earlier.

* If you have stored a program in the calculator, the number of registers available for storing cash flow amounts may be less than 21.

62 Section 4: Additional Financial Functions

Example: An investor has an opportunity to purchase a piece of property for \$79,000; and he would like a $13\frac{1}{2}\%$ return. He expects to be able to sell it after 10 years for \$100,000 and anticipates the yearly cash flows shown in the table below:

Year	Cash Flow	Year	Cash Flow
1	\$14,000	6	\$9,100
2	\$11,000	7	\$9,000
3	\$10,000	8	\$9,000
4	\$10,000	9	\$4,500
5	\$10,000	10	\$100,000

Since two cash flow amounts (\$10,000 and \$9,000) are repeated consecutively, we can minimize the number of storage registers required by using the method just described.

Keystrokes	Display	
f CLEAR REG	0.00	Clears financial and storage registers.
79000 CHS g CF0	-79,000.00	Initial investment (with minus sign for a negative cash flow).
14000 g CF1	14,000.00	First cash flow amount.
11000 g CF1	11,000.00	Next cash flow amount.
10000 g CF1	10,000.00	Next cash flow amount.
3 g N1	3.00	Number of times this cash flow amount occurs consecutively.
9100 g CF1	9,100.00	Next cash flow amount.
9000 g CF1	9,000.00	Next cash flow amount.
2 g N1	2.00	Number of times this cash flow amount occurs consecutively.
4500 g CF1	4,500.00	Next cash flow amount.
100000 g CF1	100,000.00	Final cash flow amount.
RCL n	7.00	Seven different cash flow amounts have been entered.
13.5 i	13.50	Stores <i>i</i> .
f NPV	907.77	<i>NPV</i> .

Since *NPV* is positive, the investment would increase the financial value of the investor's assets by \$907.77.

Calculating Internal Rate of Return (IRR)

1. Enter the cash flows using either of the methods described above under Calculating Net Present Value.
2. Press $\boxed{f} \boxed{IRR}$.

The calculated value of *IRR* appears in the display and also is automatically stored in the *i* register.

Note: Remember that the \boxed{IRR} function may take a significant amount of time to produce an answer, during which the calculator displays **running**.

Example: The NPV calculated in the preceding example was positive, indicating that the actual rate of return (that is, the *IRR*) was greater than the $13\frac{1}{2}$ used in the calculation. Find the *IRR*.

Assuming the cash flows are still stored in the calculator, we need only press $\boxed{f} \boxed{IRR}$:

Keystrokes	Display
$\boxed{f} \boxed{IRR}$	13.72 <i>IRR</i> is 13.72%.

Note that the value calculated by \boxed{IRR} is the *periodic* rate of return. If the cash flow periods are other than years (for example, months or quarters), you can calculate the nominal annual rate of return by multiplying the periodic *IRR* by the number of periods per year.

As noted above, the calculator may take several seconds or even minutes to produce an answer for *IRR*. This is because the mathematical calculations for finding *IRR* are extremely complex, involving a series of iterations — that is, a series of successive calculations. In each iteration, the calculator uses an estimate of *IRR* as the interest rate in a computation of *NPV*. The iterations are repeated until the computed *NPV* reaches about zero.*

If you do not want to wait for the computation of *IRR* to be completed, press any key. This halts the computation of *IRR* and displays the estimated value of *IRR* being used in the current iteration.† You can then check how good this estimate is by calculating *NPV* using this estimate: if the estimate is close to *IRR*, the *NPV* calculated with it should be close to zero.* The values of *IRR* is put into the *i* register at the end of each iteration. Therefore, to check how good an estimate of *IRR* is after that estimate is in the display, just press $\boxed{f} \boxed{NPV}$.

* In practice, because the complex mathematical calculations inside the calculator are done with numbers rounded to 10 digits, *NPV* may never reach exactly zero. Nevertheless, the interest rate that results in a very small *NPV* is very close to the actual *IRR*.

† Provided the first iteration has been completed.

64 Section 4: Additional Financial Functions

The complex mathematical characteristics of the *IRR* computation have an additional ramification: Depending on the magnitudes and signs of the cash flows, the computation of *IRR* may have a single answer, multiple answers, a negative answer or no answer.*

For additional information regarding $\boxed{\text{IRR}}$, refer to Appendix B. For an alternative method of calculating *IRR*, refer to Section 13.

Reviewing Cash Flow Entries

- To display a single cash flow amount, press $\boxed{\text{RCL}}$, then key in the number of the register containing the cash flow amount to be displayed. Alternatively, store the number of that cash flow amount (that is, the value of j for the CF_j desired) in the **n** register, then press $\boxed{\text{RCL}} \boxed{9} \boxed{CFj}$.
- To review *all* the cash flow amounts, press $\boxed{\text{RCL}} \boxed{9} \boxed{CFj}$ repeatedly. This displays the cash flow amounts in *reverse* order — that is, beginning with the final cash flow and proceeding to CF_0 .
- To display the number of times a cash flow amount occurs consecutively — that is, to display the N_j for a CF_j — store the number of that cash flow amount (that is, the value of j) in the **n** register, then press $\boxed{\text{RCL}} \boxed{9} \boxed{Nj}$.
- To review all the cash flow amounts together with the number of times each cash flow amount occurs consecutively (that is, to review each CF_j and N_j pair), press $\boxed{\text{RCL}} \boxed{9} \boxed{Nj} \boxed{\text{RCL}} \boxed{9} \boxed{CFj}$ repeatedly. This displays N_j followed by CF_j beginning with the final cash flow amount and proceeding to N_0 and CF_0 .

Note: Neither $\boxed{\text{IRR}}$ nor $\boxed{\text{NPV}}$ change the number in the **n** register. However, each time $\boxed{\text{RCL}} \boxed{9} \boxed{CFj}$ is pressed, the number in the **n** register is decreased by 1. If this is done, or if you manually change the number in the **n** register in order to display a single N_j and/or CF_j , be sure to reset the number in the **n** register to the total number of cash flow amounts originally entered (*not* including the amount of the initial investment CF_0). If this is not done, *NPV* and *IRR* calculations will give incorrect results; also, a review of cash flow entries would begin with N_n and CF_n , where n is the number currently in the **n** register.

For example, to display the fifth cash flow amount and the number of times that amount occurs consecutively:

Keystrokes	Display	
$\boxed{\text{RCL}} \boxed{5}$	9,000.00	CF_5
$5 \boxed{\text{n}}$	5.00	Stores the value of j in the n register.

* In the case of multiple answers for *IRR*, the decision criteria listed on page 57 should be modified accordingly.

Keystrokes	Display	
$\boxed{\text{RCL}} \boxed{9} \boxed{N_i}$	2.00	N_5
$7 \boxed{n}$	7.00	Resets the number in the n register to its original value.

To display all the cash flow amounts and the number of times they occur consecutively:

Keystrokes	Display	
$\boxed{\text{RCL}} \boxed{9} \boxed{N_i}$	1.00	N_7
$\boxed{\text{RCL}} \boxed{9} \boxed{CF_j}$	100,000.00	CF_7
$\boxed{\text{RCL}} \boxed{9} \boxed{N_i}$	1.00	N_6
$\boxed{\text{RCL}} \boxed{9} \boxed{CF_j}$	4,500.00	CF_6
$\boxed{\text{RCL}} \boxed{9} \boxed{N_i}$	2.00	N_5
$\boxed{\text{RCL}} \boxed{9} \boxed{CF_j}$	9,000.00	CF_5
.	.	.
.	.	.
.	.	.
$\boxed{\text{RCL}} \boxed{9} \boxed{N_i}$	1.00	N_1
$\boxed{\text{RCL}} \boxed{9} \boxed{CF_j}$	14,000.00	CF_1
$\boxed{\text{RCL}} \boxed{9} \boxed{N_i}$	1.00	N_0
$\boxed{\text{RCL}} \boxed{9} \boxed{CF_j}$	-79,000.00	CF_0
$7 \boxed{n}$	7.00	Resets the number in the n register to its original value.

Changing Cash Flow Entries

- To change a cash flow amount:
 1. Key the amount into the display.
 2. Press $\boxed{\text{STO}}$.
 3. Key in the number of the register containing the cash flow amount to be changed.
- To change the number of times a cash flow amount occurs consecutively — that is, to change the N_j for a CF_j :
 1. Store the number of that cash flow amount (that is, j) in the **n** register.
 2. Key the number of times the cash flow amount occurs consecutively into the display.
 3. Press $\boxed{9} \boxed{N_i}$.

66 Section 4: Additional Financial Functions

Note: If you change the number in the n register in order to change an N_p , be sure to reset the number in the n register to the total number of cash flow amounts originally entered (not including the amount of the initial investment CF_0). If this is not done, NPV and IRR calculations will give incorrect results.

Example 1: With the cash flows now stored in the calculator, change CF_2 from \$11,000 to \$9,000, then calculate the new NPV for a $13\frac{1}{2}\%$ return.

Keystrokes	Display	
9000 $\overline{\text{STO}}$ 2	9,000.00	Stores the new CF_2 in R_2 .
13.5 $\overline{\text{i}}$	13.50	Stores i .*
$\overline{\text{f}}$ NPV	-644.75	The new NPV .

Since this NPV is negative, the investment would decrease the financial value of the investor's assets.

Example 2: Change N_5 from 2 to 4, then calculate the new NPV .

Keystrokes	Display	
5 $\overline{\text{n}}$	5.00	Stores j in the n register.
4 $\overline{\text{g}}$ $\overline{\text{Ni}}$	4.00	Stores the new N_5 .
7 $\overline{\text{n}}$	7.00	Resets the number in the n register to its original value.
$\overline{\text{f}}$ NPV	-1,857.21	The new NPV .

Bond Calculations

The hp 12c enables you to solve for bond price (and the interest accrued since the last interest date) and the yield to maturity.† The $\overline{\text{PRICE}}$ and $\overline{\text{YTM}}$ calculations are done assuming a semiannual coupon payment and using an actual/actual basis (such as for U.S. Treasury bonds and U.S. Treasury notes). In accordance with market convention, prices are based on a redemption (par) value of 100.

* This step is necessary in this example because we have calculated IRR since the first time we calculated NPV . The IRR calculation replaced the 13.5 we keyed into i before calculating NPV with the result for IRR – 13.72.

† All bond calculations are performed in accordance with the Securities Industry Association's recommendations as contained in Spence, Graudenz, and Lynch, *Standard Securities Calculation Methods*, Securities Industry Association, New York, 1973.

To calculate bond price and yield for a 30/360 bond (that is, using the basis of a 30-day month and a 360-day year — such as for municipal bonds, corporate bonds, and state and local government bonds), and to calculate bond price for bonds with an annual coupon payment, refer to Section 16: Bonds.

Bond Price

1. Enter the desired yield to maturity (as a percentage), using **i**.
2. Enter the annual coupon rate (as a percentage), using **PMT**.
3. Key in the settlement (purchase) date (as described on page 29), then press **ENTER**.
4. Key in the maturity (redemption) date.
5. Press **f PRICE**.

The price is shown in the display and also is stored in the PV register. The interest accrued since the last interest date is held inside the calculator: to display the interest, press **x2y**; to add the interest to the price, press **+**.

Example: What price should you pay on April 28, 2004 for a 6³/₄% U.S. Treasury bond that matures on June 4, 2018, if you want a yield of 8¹/₄%. Assume that you normally express dates in the month-day-year format.

Keystrokes	Display	
8.25 i	8.25	Enters yield to maturity.
6.75 PMT	6.75	Enters coupon rate.
g M.DY	6.75	Sets date format to month-day-year.
4.282004 ENTER	4.28	Enters settlement (purchase) date.
6.042018	6.042018	Enters maturity (redemption) date.
f PRICE	87.62	Bond price (as a percent of par).
+	90.31	Total price, including accrued interest.

Bond Yield

1. Enter the quoted price (as a percent of par), using **PV**.
2. Enter the annual coupon rate (as a percentage), using **PMT**.
3. Key in the settlement (purchase) date, then press **ENTER**.
4. Key in the maturity (redemption) date.
5. Press **f YTM**.

The yield to maturity is shown in the display and also is stored in the i register.

Note: Remember that the **YTM** function may take a significant amount of time to produce an answer, during which the calculator displays **running**.

68 Section 4: Additional Financial Functions

Example: The market is quoting $88\frac{3}{8}\%$ for the bond described in the preceding example. What yield will that provide?

Keystrokes	Display	
3 \square ENTER \square 8 \square \square	0.38	Calculates $\frac{3}{8}$.
88 \square + \square PV	88.38	Enters quoted price.
6.75 \square PMT	6.75	Enters coupon rate.
4.282004 \square ENTER	4.28	Enters settlement (purchase) date.
6.042018	6.042018	Enters maturity (redemption) date.
\square f \square YTM	8.15	Bond yield.

Depreciation Calculations

The hp 12c enables you to calculate depreciation and the remaining depreciable value (book value minus salvage value) using the straight-line, sum-of-the-years-digits, and declining-balance methods. To do so with any of these methods:

1. Enter the original cost of the asset, using \square PV \square .
2. Enter the salvage value of the asset, using \square FV \square . If the salvage value is zero, press 0 \square FV \square .
3. Enter the expected useful life of the asset (in years), using \square n \square .
4. If the declining-balance method is being used, enter the declining-balance factor (as a percentage), using \square i \square . For example, $1\frac{1}{4}$ times the straight-line rate — 125 percent declining-balance — would be entered as 125 \square i \square .
5. Key in the number of the year for which depreciation is to be calculated.
6. Press:
 - \square f \square SL \square for depreciation using the straight-line method.
 - \square f \square SOYD \square for depreciation using the sum-of-the-years digits method.
 - \square f \square DB \square for depreciation using the declining-balance method.

\square SL \square , \square SOYD \square , and \square DB \square each place the amount of depreciation in the display. To display the remaining depreciable value (the book value less the salvage value) after the depreciation has been calculated, press \square X \square Y \square .

Example: A metalworking machine, purchased for \$10,000, is depreciated over 5 years. Its salvage value is estimated at \$500. Find the depreciation and remaining depreciable value for the first 3 years of the machine's life using the declining-balance method at double the straight-line rate (200 percent declining-balance).

Keystrokes	Display	
10000 <input type="text" value="PV"/>	10,000.00	Enters original cost.
500 <input type="text" value="FV"/>	500.00	Enters salvage value.
5 <input type="text" value="n"/>	5.00	Enters expected useful life.
200 <input type="text" value="i"/>	200.00	Enters declining-balance factor.
1 <input type="text" value="f"/> <input type="text" value="DB"/>	4,000.00	Depreciation in first year.
<input type="text" value="x<sup>2</sup>y"/>	5,500.00	Remaining depreciable value after first year.
2 <input type="text" value="f"/> <input type="text" value="DB"/>	2,400.00	Depreciation in second year.
<input type="text" value="x<sup>2</sup>y"/>	3,100.00	Remaining depreciable value after second year.
3 <input type="text" value="f"/> <input type="text" value="DB"/>	1,440.00	Depreciation in third year.
<input type="text" value="x<sup>2</sup>y"/>	1,660.00	Remaining depreciable value after third year.

To calculate depreciation and the remaining depreciable value when the acquisition date of the asset does not coincide with the beginning of the fiscal accounting year, refer to the procedures in Section 13. That section also includes a procedure for depreciation calculations when changing from the declining-balance method to the straight-line method, and a procedure for calculating excess depreciation.

Section 5

Additional Operating Features

Continuous Memory

The calculator's Continuous Memory contains the data storage registers, the financial registers, the stack and LAST X registers, program memory, and status information such as display format, date format, and payment mode. All information in Continuous Memory is preserved even while the calculator is turned off. Furthermore, information in Continuous Memory is preserved for a short time when the batteries are removed, so that you can change the batteries without losing your data and programs.

Continuous Memory may be reset if the calculator is dropped or otherwise traumatized, or if power is interrupted. You can also manually reset Continuous Memory as follows:

1. Turn the calculator off.
2. Hold down the \square key, and press \square ON.

When Continuous Memory is reset:

- All registers are cleared.
- Program memory consists of eight program lines, each containing the instruction \square GTO 00.
- Display format is set to the standard format with two decimal places.
- Date format is set to month-day-year.
- Payment mode is set to End.

Whenever Continuous Memory has been reset, the display will show **Pr Error**. Pressing any key will clear this message from the display.

The Display

Status Indicators

Six indicators that appear along the bottom of the display signify the status of the calculator for certain operations. These status indicators are described elsewhere in this handbook where the relevant operation is discussed.

f 9 BEGIN D.MY C PRGM

Number Display Formats

When the calculator is first turned on after coming from the factory or after Continuous Memory has been reset, answers are *displayed* with two decimal places.

Keystrokes	Display
19.8745632 \square ENTER	19.87
5 \square -	14.87

Although you see only two decimal places, all calculations in your hp 12c are performed with full 10-digit numbers.

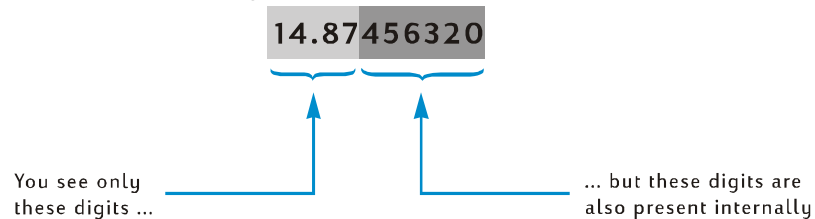

When only two decimal places are displayed, numbers are *rounded* to two decimal places: if the third digit is 5 through 9, the second digit is increased by one; if the third digit is 0 through 4, the second digit is not affected. Rounding occurs regardless of how many decimal places are displayed.

Several options are provided for controlling how numbers appear in the display. But regardless of which display format or how many displayed decimal places you specify, the number inside the calculator — which *appears* altered in the display — is not altered unless you use the \square RND, \square AMORT, \square SL, \square SOYD, or \square DB functions.

Standard Display Format. The number 14.87 now in your calculator is currently being displayed in the standard display format with two decimal places shown. To display a different number of decimal places, press \square f followed by a digit key (0 through 9) specifying the number of decimal places. In the following examples, notice how the displayed form of the number inside the calculator — 14.87456320 — is rounded to the specified number of digits.

72 Section 5: Additional Operating Features

Keystrokes	Display	
$\boxed{f}4$	14.8746	
$\boxed{f}1$	14.9	
$\boxed{f}0$	15.	
$\boxed{f}9$	14.87456320	Although nine decimal places were specified after \boxed{f} , only eight are displayed since the display can show a total of only 10 digits.

The standard display format, plus the specified number of decimal places, remain in effect until you change them; they are not reset each time the calculator is turned on. However, if Continuous Memory is reset, when the calculator is next turned on numbers will be displayed in the standard display format with two decimal places shown.

If a calculated answer is either too small or too large to be displayed in the standard display format, the display format automatically switches to scientific notation (described below). The display returns to the standard display format for all numbers that can be displayed in that format.

Scientific Notation Display Format

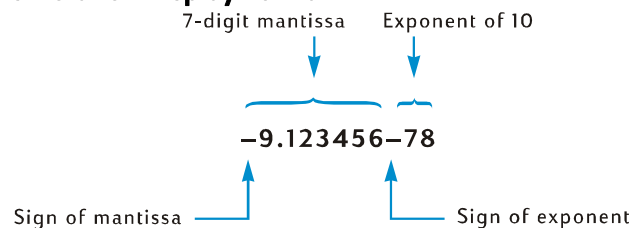

In scientific notation, a number is displayed with its *mantissa* at the left and a two-digit *exponent* at the right. The mantissa is simply the first seven digits in the number, and has a single, nonzero digit to the left of the decimal point. The exponent is simply how many decimal places you would move the decimal point in the mantissa before writing down the number in standard format. If the exponent is negative (that is, there is a minus sign between it and the mantissa), the decimal point should be moved to the left; this occurs for any number less than 1. If the exponent is positive (that is, there is a blank space between it and the mantissa), the decimal point should be moved to the right; this occurs for any number greater than or equal to 1.

To set the display format to scientific notation, press $\boxed{f}\boxed{\cdot}$. For example (assuming the display still shows **14.87456320** from the preceding example):

Keystrokes

Display

$\boxed{f} \cdot \boxed{}$

1.487456 01

The exponent in this example indicates that the decimal point should be moved one decimal place to the right, giving the number 14.87456, which is the first seven digits of the number previously in the display.

To set the display back to standard display format, press \boxed{f} followed by the desired number of decimal places. Scientific notation display format remains in effect until you change to the standard display format; it is not reset each time the calculator is turned on. However, if Continuous Memory is reset, when the calculator is next turned on the standard display format, with two decimal places, will be used.

Mantissa Display Format. Because both the standard display format and scientific notation display format often show only a few digits of a number, you may occasionally want to see all 10 digits — the full mantissa — of the number inside the calculator. To do so, press $\boxed{f} \boxed{\text{CLEAR}} \boxed{\text{PREFIX}}$ and hold down the $\boxed{\text{PREFIX}}$ key. The display will show all 10 digits of the number as long as you hold down the $\boxed{\text{PREFIX}}$ key; after you release the key, the number will again be displayed in the current display format. For instance, if the display still contains the result from the preceding example:

Keystrokes

Display

$\boxed{f} \boxed{\text{CLEAR}} \boxed{\text{PREFIX}}$

1487456320 All 10 digits of the number inside the calculator.

1.487456 01 Display returns to its former contents when the $\boxed{\text{PREFIX}}$ key is released.

$\boxed{f} \boxed{2}$

14.87 Returns display to standard format.

Special Displays

Running. Certain functions and many programs may take several seconds or more to produce an answer. During these calculations, the word **running** flashes in the display to let you know that the calculator is running.

Overflow and Underflow. If a calculation results in a number whose magnitude is greater than $9.999999999 \times 10^{99}$, the calculation is halted and the calculator displays **9.999999 99** (if the number is positive) or **-9.999999 99** (if the number is negative).

If a calculation results in a number whose magnitude is less than 10^{-99} , the calculation is not halted, but the value 0 is used for that number in subsequent calculations.

74 Section 5: Additional Operating Features

Errors. If you attempt an improper operation — such as division by zero — the calculator will display the word **Error** followed by a digit (**0** through **9**). To clear the **Error** display, press any key. This does not execute that key's function, but does restore the calculator to its condition before the improper operation was attempted. Refer to Appendix C for a list of error conditions.

Pr Error. If power to the calculator is interrupted, the calculator will display **Pr Error** when next turned on. This indicates that Continuous Memory — which contains all data, program, and status information — has been reset.

The $\boxed{\leftrightarrow}$ key

Suppose you need to subtract \$25.83 from \$144.25, and you (mistakenly) key in 25.83, press $\boxed{\text{ENTER}}$, then key in 144.25. But then you realize that when written down on paper, the desired calculation reads $144.25 - 25.83$, so that you have unfortunately keyed in the *second* number first. To correct this mistake, merely exchange the first and second numbers by pressing $\boxed{\leftrightarrow}$, the *exchange* key.

Keystrokes	Display	
25.83 $\boxed{\text{ENTER}}$ 144.25	144 . 25	Oops! You mistakenly keyed in the <i>second number first</i> .
$\boxed{\leftrightarrow}$	25 . 83	Exchanges the first and second numbers. The first number keyed in is now in the display.
$\boxed{-}$	118 . 42	The answer is obtained by pressing the operation key.

The $\boxed{\leftrightarrow}$ key is also useful for checking the first number entered to make sure you keyed it in correctly. Before pressing the operation key, however, you should press $\boxed{\leftrightarrow}$ again to return the second number entered to the display. Regardless of how many times you press $\boxed{\leftrightarrow}$, the calculator considers the number in the display to be the *second* number entered.

The $\boxed{\text{LST}\langle x \rangle}$ Key

Occasionally you may want to recall to the display the number that was there before an operation was performed. (This is useful for doing arithmetic calculations with constants and for recovering from errors in keying in numbers.) To do so, press $\boxed{\text{g}}\boxed{\text{LST}\langle x \rangle}$ (*last x*).

Arithmetic Calculations With Constants

Example: At Permex Pipes a certain pipe fitting is packaged in quantities of 15, 75, and 250. If the cost per fitting is \$4.38, calculate the cost of each package.

Keystrokes	Display	
15 <input type="text" value="ENTER"/>	15 . 00	Keys first quantity into calculator.
4.38	4 . 38	Keys unit cost into display.
<input type="text" value="X"/>	65 . 70	Cost of a package of 15.
75	75 .	Keys second quantity into display.
<input type="text" value="g"/> <input type="text" value="LSTx"/>	4 . 38	Recalls unit cost — which was last number in display before <input type="text" value="X"/> was pressed — into display.
<input type="text" value="X"/>	328 . 50	Cost of a package of 75.
250	250 .	Keys third quantity into display.
<input type="text" value="g"/> <input type="text" value="LSTx"/>	4 . 38	Recalls unit cost into display again.
<input type="text" value="X"/>	1 , 095 . 00	Cost of a package of 250.

Another method for doing arithmetic calculations with constants is described on page 177.

Recovering From Errors in Digit Entry

Example: Suppose you want to divide the total annual production for one of your firm's products (429,000) by the number of retail outlets (987) in order to calculate the average number distributed by each outlet. Unfortunately, you mistakenly key in the number of outlets as 9987 rather than as 987. It's easy to correct:

Keystrokes	Display	
429000 <input type="text" value="ENTER"/>	429 , 000 . 00	
9987	9 , 987 .	You haven't noticed your mistake yet.
<input type="text" value="÷"/>	42 . 96	About 43 products per outlet — but that seems too low!
<input type="text" value="g"/> <input type="text" value="LSTx"/>	9 , 987 . 00	Recalls to the display the number that was there before you press <input type="text" value="÷"/> . You see that you keyed it in wrong.
429000 <input type="text" value="ENTER"/>	429 , 000 . 00	Begins the problem over.
987 <input type="text" value="÷"/>	434 . 65	The correct answer.

Section 6

Statistics Functions

Accumulating Statistics

The hp 12c can perform one- or two-variable statistical calculations. The data is entered into the calculator using the $\Sigma+$ key, which automatically calculates and stores statistics of the data into storage registers R_1 , through R_6 . (These registers are therefore referred to as the “statistics registers.”)

Before beginning to accumulate statistics for a new set of data, you should clear the statistics registers by pressing f clear Σ .*

In one-variable statistical calculations, to enter each data point — referred to as an “x-value” — key the x-value into the display, then press $\Sigma+$.

In two-variable statistical calculations, to enter each data pair — referred to as the “x and y-values”:

1. Key the y-value into the display.
2. Press ENTER .
3. Key the x-value into the display.
4. Press $\Sigma+$.

Each time you press $\Sigma+$, the calculator does the following:

- The number in R_1 is increased by 1, and the result is copied into the display.
- The x-value is added to the number in R_2 .
- The square of the x-value is added to the number in R_3 .
- The y-value is added to the number in R_4 .
- The square of the y-value is added to the number in R_5 .
- The product of the x and y-values is added to the number in R_6 .

* This also clears the stack registers and the display.

The table below shows where the accumulated statistics are stored.

Register	Statistic
R ₁ (and display)	n : number of data pairs accumulated.
R ₂	Σx : summation of x -values.
R ₃	Σx^2 : summation of squares of x -values.
R ₄	Σy : summation of y -values.
R ₅	Σy^2 : summation of squares of y -values.
R ₆	Σxy : summation of products of x -values and y -values.

Correcting Accumulated Statistics

If you discover you have entered data incorrectly, the accumulated statistics can easily be corrected:

- If the incorrect data point or data pair has just been entered and $\Sigma+$ has been pressed, press $\text{g} \text{LSTx} \text{g} \Sigma-$.
- If the incorrect data point or data pair is not the most recent one entered, key in the incorrect data point or data pair again as if it were new, but press $\text{g} \Sigma-$ instead of $\Sigma+$.

These operations cancel the effect of the incorrect data point or data pair. You can then enter the data correctly, using $\Sigma+$, just as if it were new.

Mean

Pressing $\text{g} \bar{x}$ calculates the means (arithmetic averages) of the x -values (\bar{x}) and of the y -values (\bar{y}). The mean of the x -values appears in the display after \bar{x} is pressed; to display the mean of the y -values, press $\text{x} \bar{y}$.

Example: A survey of seven salespersons in your company reveals that they work the following hours a week and sell the following dollar volumes each month. How many hours does the average salesperson work each week? How much does the average salesperson sell each month?

78 Section 6: Statistics Functions

Salesperson	Hours/Week	Hours/Week
1	32	\$17,000
2	40	\$25,000
3	45	\$26,000
4	40	\$20,000
5	38	\$21,000
6	50	\$28,000
7	35	\$15,000

To find the average workweek and sales of this sample:

Keystrokes	Display	
\boxed{f} CLEAR $\boxed{\Sigma}$	0 . 00	Clears statistics registers.
32 \boxed{ENTER}	32 . 00	
17000 $\boxed{\Sigma+}$	1 . 00	First entry.
40 \boxed{ENTER}	40 . 00	
25000 $\boxed{\Sigma+}$	2 . 00	Second entry.
45 \boxed{ENTER}	45 . 00	
26000 $\boxed{\Sigma+}$	3 . 00	Third entry.
40 \boxed{ENTER}	40 . 00	
20000 $\boxed{\Sigma+}$	4 . 00	Fourth entry.
38 \boxed{ENTER}	38 . 00	
21000 $\boxed{\Sigma+}$	5 . 00	Fifth entry.
50 \boxed{ENTER}	50 . 00	
28000 $\boxed{\Sigma+}$	6 . 00	Sixth entry.
35 \boxed{ENTER}	35 . 00	
15000 $\boxed{\Sigma+}$	7 . 00	Total number of entries in the sample.
\boxed{g} $\boxed{\bar{x}}$	21 , 714 . 29	Mean dollar sales per month (\bar{x}).
$\boxed{\times \div}$ \boxed{y}	40 . 00	Mean workweek in hours (\bar{y}).

Standard Deviation

Pressing $\boxed{g} \boxed{S}$ calculates the standard deviation of the x -values (s_x) and of the y -values (s_y). (The standard deviation of a set of data is a measure of the dispersion around the mean.) The standard deviation of the x -values appears in the display after \boxed{S} is pressed; to display the standard deviation of the y -values, press $\boxed{X \leftrightarrow Y}$.

Example: To calculate the standard deviations of the x -values and of the y -values from the preceding example:

Keystrokes	Display	
$\boxed{g} \boxed{S}$	4,820.59	Standard deviation of sales.
$\boxed{X \leftrightarrow Y}$	6.03	Standard deviation of hours worked.

The formulas used in the hp 12c for calculating s_x and s_y give *best estimates* of the population standard deviation based on a sample of the population. Thus, current statistical convention calls them *sample* standard deviations. So we have assumed that the seven salespersons are a sample of the population of *all salespersons*, and our formulas derive best estimates of the population from the sample.

What if the seven salespersons constituted the whole population of salespersons. Then we wouldn't need to *estimate* the *population* standard deviation. We can find the *true population* standard deviation (σ) when the data set equals the total population, using the following keystrokes.*

Keystrokes	Display	
$\boxed{g} \boxed{\bar{x}}$	21,714.29	Mean (dollars)
$\boxed{\Sigma+}$	8.00	Number of entries + 1.
$\boxed{g} \boxed{S}$	4,463.00	σ_x
$\boxed{X \leftrightarrow Y}$	5.58	σ_y

To continue summing data pairs, press $\boxed{g} \boxed{\bar{x}} \boxed{g} \boxed{\Sigma-}$ before entering more data.

* It turns out that if you sum the mean of the population into the set itself and find the new s , computed using the formulas on page 192, that s will be the *population* standard deviation, σ , of the original set.

Linear Estimation

With two-variable statistical data accumulated in the statistics registers, you can estimate a new y -value (\hat{Y}) given a new x -value, and estimate a new x -value (\hat{X}) given a new y -value.

To calculate \hat{Y} :

1. Key in a new x -value.
2. Press $\boxed{\text{g}}\boxed{\hat{Y},r}$.

To calculate \hat{X} :

1. Key in a new y -value.
2. Press $\boxed{\text{g}}\boxed{\hat{X},r}$.

Example: Using the accumulated statistics from the preceding problem, estimate the amount of sales delivered by a new salesperson working 48 hours per week.

Keystrokes	Display	
48 $\boxed{\text{g}}\boxed{\hat{X},r}$	28,818.93	Estimated sales for a 48 hour workweek.

The reliability of a linear estimate depends upon how closely the data pairs would, if plotted on a graph, lie in a straight line. The usual measure of this reliability is the correlation coefficient, r . This quantity is automatically calculated whenever \hat{Y} or \hat{X} is calculated; to display it, press $\boxed{\text{x}\hat{r}\text{y}}$. A correlation coefficient close to 1 or -1 indicates that the data pairs lie very close to a straight line. On the other hand, a correlation coefficient close to 0 indicates that the data pairs do not lie closely to a straight line; and a linear estimate using this data would not be very reliable.

Example: Check the reliability of the linear estimate in the preceding example by displaying the correlation coefficient.

Keystrokes	Display	
$\boxed{\text{x}\hat{r}\text{y}}$	0.90	The correlation coefficient is close to 1, so the sales calculated in the preceding example is a good estimate.

To graph the regression line, calculate the coefficients of the linear equation $y = A + Bx$.

1. Press $0\boxed{\text{g}}\boxed{\hat{Y},r}$ to compute the y -intercept (A).
2. Press $1\boxed{\text{g}}\boxed{\hat{Y},r}\boxed{\text{x}\hat{r}\text{y}}\boxed{\text{R}\downarrow}\boxed{\text{x}\hat{r}\text{y}}\boxed{-}$ to compute the slope of the line (B).

Example: Compute the slope and intercept of the regression line in the preceding example.

Keystrokes	Display	
0 \square \square \square \square	15.55	y-intercept (A); projected value for x = 0.
1 \square \square \square \square \square \square \square \square \square \square	0.001	Slope of the line (B); indicates the change in the projected values caused by an incremental change in the x value.

The equation that describes the regression line is:

$$y = 15.55 + 0.001x$$

Weighted Mean

You can compute the weighted mean of a set of numbers if you know the corresponding weights of the items in question.

1. Press \square \square \square \square .
2. Key in the value of the item and press \square , then key in its weight and press \square . Key in the second item's value, press \square , key in the second weight, and press \square . Continue until you have entered all the values of the items and their corresponding weights. The rule for entering the data is "item \square weight \square ."
3. Press \square \square to calculate the weighted mean of the items.

Example: Suppose that you stop during a vacation drive to purchase gasoline at four stations as follows: 15 gallons at \$1.16 per gallon, 7 gallons at \$1.24 per gallon, 10 gallons at \$1.20 per gallon, and 17 gallons at \$1.18 per gallon. You want to find the average cost per gallon of gasoline purchased. If you purchased the same quantity at each station, you could determine the simple arithmetic average or mean using the \square key. But since you know the value of the item (gasoline) and its corresponding weight (number of gallons purchased), use the \square key to find the weighted mean:

Keystrokes	Display	
\square \square \square \square	0.00	Clears statistics registers.
1.16 \square 15 \square	1.00	First item and weight.
1.24 \square 7 \square	2.00	Second item and weight.
1.20 \square 10 \square	3.00	Third item and weight.
1.18 \square 17 \square	4.00	Fourth item and weight.

82 Section 6: Statistics Functions

Keystrokes

$\boxed{g} \boxed{\bar{x}_w}$

Display

1.19

Weighted mean cost per gallon.

A procedure for calculating the standard deviation and standard error (as well as the mean) of weighted or grouped data is included in the *hp 12c Solutions Handbook*.

Section 7

Mathematics and Number-Alteration Functions

The *hp 12c* provides several keys for mathematical functions and for altering numbers. These functions are useful for specialized financial calculations as well as for general mathematics calculations.

One-Number Functions

Most of the mathematics functions require that only one number be in the calculator (that is, the number in the display) before the function key is pressed. Pressing the function key then replaces the number in the display by the result.

Reciprocal. Pressing $\frac{1}{x}$ calculates the reciprocal of the number in the display — that is, it divides 1 by the number in the display.

Square Root. Pressing \sqrt{x} calculates the square root of the number in the display.

Logarithm. Pressing \ln calculates the natural logarithm (that is, the logarithm to the base e) of the number in the display. To calculate the common logarithm (that is, the logarithm to the base 10) of the number in the display, calculate the natural logarithm, then press 10^{\square} .

Exponential. Pressing e^x calculates the exponential of the number in the display — that is, it raises the base e to the number in the display.

Factorial. Pressing $n!$ calculates the factorial of the number in the display — that is, it calculates the product of the integers from 1 to n , where n is the number in the display.

Round. The display format specifies to how many decimal places a number inside the calculator is rounded when it appears in the display; but the display format alone does not affect the number itself inside the calculator. Pressing $\text{f} \text{RND}$, however, changes the number inside the calculator to match its displayed version. Thus, to round a number in the display to a given number of decimal places, temporarily set the display format (as described on page 71) to show the desired number of decimal places, then press $\text{f} \text{RND}$.

Integer. Pressing $\text{g} \text{INTG}$ replaces the number in the display by its integer portion — that is, it replaces each digit to the right of the decimal point by 0. The number is changed inside the calculator as well as in the display. The original number can be recalled to the display by pressing $\text{g} \text{LSTX}$.

84 Section 7: Mathematics and Number-Alteration Functions

Fractional. Pressing $\boxed{g} \boxed{\text{FRAC}}$ replaces the number in the display by its fractional portion — that is, it replaces all digits to the left of the decimal point by 0. Like $\boxed{\text{INTG}}$, $\boxed{\text{FRAC}}$ changes the number inside the calculator as well as its displayed version. The original number can be recalled to the display by pressing $\boxed{g} \boxed{\text{LSTX}}$.

All of the above functions are used basically in the same way. For example, to find the reciprocal of 0.258:

Keystrokes	Display	
.258	0 . 258	Keys the number into the display.
$\boxed{\frac{1}{x}}$	3 . 88	The reciprocal of 0.258, the original number.

Any of the above functions can be done with a number in the display resulting from a previous calculation, as well as with a number you have just keyed in.

Keystrokes	Display	
$\boxed{f} \boxed{\text{CLEAR}} \boxed{\text{PREFIX}}$	3875968992	Displays all 10 digits of the number inside the calculator.
	3 . 88	Display returns to normal format when $\boxed{\text{PREFIX}}$ key is released.
$\boxed{f} \boxed{\text{RND}}$	3 . 88	The number now in the display appears the same as before, but ...
$\boxed{f} \boxed{\text{PREFIX}}$	3880000000	Displaying all 10 digits of the number inside the calculator shows $\boxed{\text{RND}}$ has changed the number to match its displayed version.
	3 . 88	Display returns to normal format.
$\boxed{g} \boxed{\text{INTG}}$	3 . 00	The integer portion of the number previously displayed.
$\boxed{g} \boxed{\text{LSTX}}$	3 . 88	Recalls the original number to the display.
$\boxed{g} \boxed{\text{FRAC}}$	0 . 88	The fractional portion of the number previously displayed.

The Power Function

Pressing y^x calculates a power of a number — that is, y^x . Like the arithmetic function \pm , y^x requires two numbers:

1. Key in the base number (which is designated by the y on the key).
2. Press ENTER to separate the second number (the exponent) from the first (the base).
3. Key in the exponent (which is designated by the x on the key).
4. Press y^x to calculate the power.

To Calculate	Keystrokes	Display
$2^{1.4}$	2 ENTER 1.4 y^x	2.64
$2^{-1.4}$	2 ENTER 1.4 CHS y^x	0.38
$(-2)^3$	2 CHS ENTER 3 y^x	-8.00
$\sqrt[3]{2}$ or $2^{1/3}$	2 ENTER 3 $\frac{1}{x}$ y^x	1.26

Part II

Programming

Section 8

Programming Basics

Why Use Programs?

A program is simply a sequence of keystrokes that is stored in the calculator. Whenever you have to calculate with the same sequence of keystrokes several times, you can save a great deal of time by incorporating these keystrokes in a program. Instead of pressing all the keys each time, you press just one key to start the program: the calculator does the rest automatically!

Creating a Program

Creating a program consists simply of writing the program, then *storing* it:

1. Write down the sequence of keystrokes that you would use to calculate the quantity or quantities desired.
2. Press $\boxed{f} \boxed{P/R}$ to set the calculator to *Program mode*. When the calculator is in Program mode, functions are not executed when they are keyed in, but instead are stored inside the calculator. The **PRGM** status indicator in the display is lit when the calculator is in Program mode.
3. Press $\boxed{f} \boxed{CLEAR} \boxed{PRGM}$ to erase any previous programs that may be stored inside the calculator. If you want to create a new program without erasing a program already stored, skip this step and proceed as described in Section 11, Multiple Programs.
4. Key in the sequence of keystrokes that you wrote down in step 1. Skip the beginning keystrokes that enter data, which would differ each time the program is used.

Example: Your office supplies dealer is selling selected stock at 25% off. Create a program that calculates the net cost of an item after the discount is subtracted and the \$5 handling charge is added.

First, we'll manually calculate the net cost of an item listing for \$200.

Keystrokes	Display	
200	200 .	Keys in cost of item.
\boxed{ENTER}	200 . 00	Separates cost of item from percentage to be keyed in next.
25 $\boxed{\%}$	50 . 00	Amount of discount.

Keystrokes	Display	
\square	150.00	Price less discount.
5	5.	Handling charge.
\square	155.00	Net cost (price less discount plus handling charge).

Next, set the calculator to Program mode and erase any program(s) already stored:

Keystrokes	Display	
\square \square P/R	00-	Sets calculator to Program mode.
\square CLEAR \square PRGM	00-	Clears program(s).

Finally, press the keys that we used above to solve the problem manually. Do not key in 200; this number will vary each time the program is used. Don't be concerned right now about what appears in the display as you press the keys; we'll discuss that later in this section.

Keystrokes	Display	
\square ENTER	01-	36
2	02-	2
5	03-	5
\square %	04-	25
\square	05-	30
5	06-	5
\square	07-	40

Running a Program

To run (sometimes called "execute") a program:

1. Press \square \square P/R to set the calculator back to Run mode. If the calculator is already in Run mode (that is, the **PRGM** status indicator in the display is not lit), skip this step.
2. Key any required data into the calculator, just as if you were calculating manually. When a program is run, it uses the data already keyed into the display and the registers inside the calculator.
3. Press \square R/S to begin program execution.

90 Section 8: Programming Basics

Example: Run the program created above to calculate the net cost of a typewriter listing for \$625 and an executive chair listing for \$159.

Keystrokes	Display	
<code>f</code> <code>P/R</code>	155.00	Sets calculator to Run mode. Display shows number previously calculated.
625	625.	Keys in price of typewriter.
<code>R/S</code>	473.75	Net cost of typewriter.
159	159.	Keys in list price of chair.
<code>R/S</code>	124.25	Net cost of chair.

That's all there is to creating and running simple programs! But if you want to use programs frequently, you'll want to know more about programming — such as how to check what keystrokes are stored in program memory, how many keystrokes can be stored in program memory, how to correct or otherwise modify programs, how to skip keystrokes when running a program, and so on. Before you can understand these aspects of programming, we need to briefly discuss how keystrokes are treated by the calculator when they are stored in Program mode and when they are executed in Run mode.

Program Memory

Keystrokes entered into the calculator in Program mode are stored in *program memory*. Each digit, decimal point, or function key is called an *instruction* and is stored in one *line* of program memory — usually referred to simply as a *program line*. Keystroke sequences beginning with the `f`, `g`, `STO`, `RCL`, and `GTO` prefix keys are considered to comprise a *complete instruction* and are stored in only one program line.

When a program is run, each instruction in program memory is executed — that is, the keystroke in that program line is performed, just as if you were pressing the key manually — beginning with the current line in program memory and proceeding sequentially with the higher-numbered program lines.

Whenever the calculator is in Program mode (that is, whenever the **PRGM** status indicator in the display is lit), the display shows information about the program line to which the calculator is currently set. At the left of the display is the number of the program line within program memory. The remaining digits in the display comprise a code that indicates what instruction has been stored in that program line. No code is shown for program line 00, since no regular instruction is stored there.

Identifying Instructions in Program Lines

Each key on the hp 12c keyboard — except for the digit keys 0 through 9 — is identified by a two-digit “keycode” that corresponds to the key’s position on the keyboard. The first digit in the keycode is the number of the key row, counting from row 1 at the top; the second digit is the number of the key in that row, counting from 1 for the first key in the row through 9 for the ninth key in the row and 0 for the tenth key in the row. The keycode for each digit key is simply the digit on the key. Thus, when you keyed the instruction [%] into program memory, the calculator displayed

04- 25

This indicates that the key for the instruction in program line 04 is in the second row on the keyboard and is the fifth key in that row: the [%] key. When you keyed the instruction [+] into program memory, the calculator displayed

07- 40

This indicates that the key for the instruction in program line 07 is in the fourth row on the keyboard and is the tenth key in that row: the [+] key. When you keyed the digit 5 into program memory, the keycode displayed was only the digit 5.

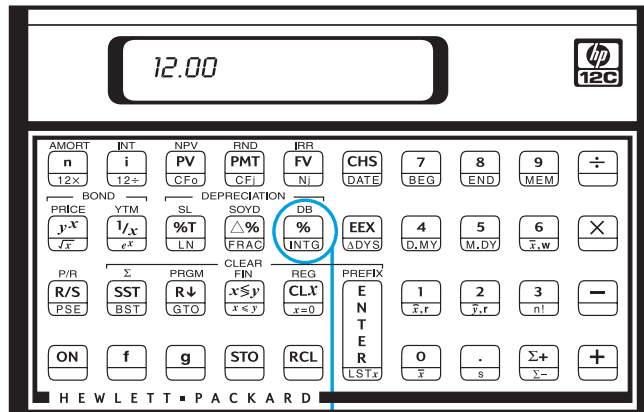

Second row, fifth key

Since keystroke sequences beginning with [f], [g], [STO], [RCL], and [GTO] are stored in only one program line, the display of that line would show the keycodes for all the keys in the keystroke sequence.

Instruction	Keycode
[9] [ADYS]	nn- 43 26
[STO] [+] 1	nn- 44 40 1
[9] [GTO] 00	nn- 43,33 00

92 Section 8: Programming Basics

Displaying Program Lines

Pressing \boxed{f} $\boxed{P/R}$ to set the calculator from Run mode to Program mode displays the line number and keycode for the program line to which the calculator is currently set.

Occasionally you'll want to check several or all of the instructions stored in program memory. The hp 12c enables you to review program instructions either forward or backward through program memory:

- Pressing \boxed{SST} (*single step*) while the calculator is in Program mode advances the calculator to the next line in program memory, then displays that line number and the keycode of the instruction stored there.
- Pressing \boxed{g} \boxed{BST} (*back step*) while the calculator is in Program mode sets the calculator back to the previous line in program memory, then displays that line number and the keycode of the instruction stored there.

For example, to display the first two lines of the program now stored in program memory, set the calculator to Program mode and press \boxed{SST} twice:

Keystrokes	Display	
\boxed{f} $\boxed{P/R}$	00-	Sets calculator to Program mode and displays current line of program memory
\boxed{SST}	01-	36 Program line 01: \boxed{ENTER}
\boxed{SST}	02-	2 Program line 02: digit 2.

Pressing \boxed{g} \boxed{BST} does the reverse:

Keystrokes	Display	
\boxed{g} \boxed{BST}	01-	36 Program line 01.
\boxed{g} \boxed{BST}	00-	Program line 00.

If either the \boxed{SST} key or the \boxed{BST} key is held down, the calculator displays *all* of the lines in program memory. Press \boxed{SST} again now, but this time hold it down until program line 07 is displayed.

Keystrokes	Display	
\boxed{SST}	01-	36 Program line 01
	.	.
	.	.
	.	.
(Release \boxed{SST})	07-	40 Program line 07

Program line 07 contains the last instruction you keyed into program memory. However, if you press **[SST]** again, you'll see that this is *not* the last line stored in program memory:

Keystrokes	Display
[SST]	08- 43, 33 00 Program line 08

As you should now be able to tell from the keycodes displayed, the instruction in program line 08 is **[g]GTO00**.

The **[GTO]00** Instruction and Program Line 00

Whenever you run the program now stored in program memory, the calculator executes the instruction in line 08 after executing the seven instructions you keyed in. This **[GTO]00** instruction — as its name implies — tells the calculator to “go to” program line 00 and execute the instruction in that line. Although line 00 does not contain a regular instruction, it does contain a “hidden” instruction that tells the calculator to halt program execution. Thus, after each time the program is run, the calculator automatically goes to program line 00 and halts, ready for you to key in new data and run the program again. (The calculator is also automatically set to program line 00 when you press **[f]P/R** to set the calculator from Program mode to Run mode.)

The **[GTO]00** instruction was already stored in line 08 — in fact, in *all* program lines — *before* you keyed in the program. If no instructions have been keyed into program memory, if Continuous Memory is reset, or if **[f]CLEAR^{PRGM}** is pressed (in Program mode), the instruction **[GTO]00** is automatically stored in program lines 01 through 08. As you key each instruction into program memory, it replaces the **[GTO]00** instruction in that program line.

If your program should consist of exactly eight instructions, there would be no **[GTO]00** instructions remaining at the end of program memory. Nevertheless, after such a program is executed the calculator automatically returns to program line 00 and halts, just as if there were a **[GTO]00** instruction following the program.

If you key in more than eight instructions, program memory automatically expands to accommodate the additional instructions.

94 Section 8: Programming Basics

Expanding Program Memory

If no instructions have been keyed into program memory, if Continuous Memory has been reset, or if \boxed{f} CLEAR \boxed{PRGM} has been pressed (in Program mode), program memory consists of 8 program lines, and there are 20 storage registers available for storage of data.

Program Memory

00
01
02
03
04
05
06
07
08

Storage Registers

R ₀	<input type="text"/>	R ₀	<input type="text"/>
R ₁	<input type="text"/>	R ₁	<input type="text"/>
R ₂	<input type="text"/>	R ₂	<input type="text"/>
R ₃	<input type="text"/>	R ₃	<input type="text"/>
R ₄	<input type="text"/>	R ₄	<input type="text"/>
R ₅	<input type="text"/>	R ₅	<input type="text"/>
R ₆	<input type="text"/>	R ₆	<input type="text"/>
R ₇	<input type="text"/>	R ₇	<input type="text"/>
R ₈	<input type="text"/>	R ₈	<input type="text"/>
R ₉	<input type="text"/>	R ₉	<input type="text"/>

As you key in a ninth instruction, storage register R₉ is automatically converted into seven new lines of program memory. The instruction you key in is stored in program line 09, and the instruction \boxed{GTO} 00 is automatically stored in program lines 10 through 15.

Program Memory

00
01
02
⋮
09
10
11
12
13
14
15

Storage Registers

R ₀	<input type="text"/>
R ₁	<input type="text"/>
⋮	
R ₅	<input type="text"/>
R ₆	<input type="text"/>
R ₇	<input type="text"/>
R ₈	<input type="text"/>
R ₉	<input type="text"/>



Program memory is automatically expanded like this whenever another seven instructions have been keyed into program memory — that is, when you key an instruction into program line 16, 23, 30 etc. In each case, the additional program lines made available are converted, seven lines at a time, from the last available data storage register (whether or not data has been stored in that register; if it has, it will be lost). Furthermore, the six new program lines (following the 16th, 23th etc.) will each contain the instruction `GTO00`.

To determine at any time how many program lines (including those containing `GTO00`) are currently in program memory and how many storage registers are currently available for conversion to program lines or for data storage, press `9 MEM` (memory). The calculator will respond with a display like the following:

$$\begin{array}{ccc} \text{P-08} & & \text{r-20} \\ \underbrace{\hspace{1.5cm}} & & \underbrace{\hspace{1.5cm}} \\ \uparrow & & \uparrow \\ \text{Allocated program lines} & & \text{Available storage registers} \end{array}$$

Up to 99 instructions can be stored in program memory. Doing so would require the conversion of 13 data storage registers (because $99 = 8 + [13 \times 7]$), leaving 7 storage registers — R_0 through R_6 — available for data storage.

If you find yourself creating long programs, you should create your programs so that they don't use up program lines unnecessarily, since program memory is limited to 99 program lines. One way to minimize program length is to replace numbers consisting of more than just one digit — like the number 25 in lines 02 and 03 of the program keyed in above — by a `RCL` instruction, and then storing the number in the designated storage register before running the program. In this case, this would save one program line, since the `RCL` instruction requires only one program line, not two as are required by the number 25. Of course, doing so uses up data storage registers that you might want to save for other data. As in many business and financial decisions, there is a trade off involved; here it is between program lines and data storage registers.

Setting the Calculator to a Particular Program Line

There will be occasions when you'll want to set the calculator directly to a particular program line — such as when you're storing a second program in program memory or when you're modifying an existing program. Although you can set the calculator to any line by using `SST` as described above, you can do so more quickly as follows:

- With the calculator in Program mode, pressing `9 GTO` followed by two digit keys sets the calculator to the program line specified by the digit keys, and then displays that line number and the keycode of the instruction stored there.

96 Section 8: Programming Basics

- With the calculator in Run mode, pressing $\boxed{9} \boxed{GTO} \boxed{\cdot} \boxed{00}$ followed by two digit keys sets the calculator to the program line specified by the digit keys. Since the calculator is not in Program mode, the line number and keycode are not displayed.

The decimal point is not necessary if the calculator is in Run mode, but it is necessary if the calculator is in Program mode.

For example, assuming the calculator is still in Program mode, you can set it to program line 00 as follows:

Keystrokes	Display	
$\boxed{9} \boxed{GTO} \boxed{\cdot} \boxed{00}$	00-	Program line 00

Executing a Program One Line at a Time

Pressing \boxed{SST} repeatedly with the calculator in Program mode (as described earlier) enables you to verify that the program you have *stored* is identical to the program you *wrote* — that is, to verify that you have keyed the instructions in correctly. However, this does not ensure that the program you *wrote* calculates the desired results correctly: even programs created by the most experienced programmers often do not work correctly when they are first written.

To help you verify that your program works correctly, you can execute the program one line at a time, using the \boxed{SST} key. Pressing \boxed{SST} while the calculator is in Run mode advances the calculator to the next line in program memory, then displays that line's number and the keycode of the instruction stored there, just as in Program mode. In *Run* mode, however, when the \boxed{SST} key is released the instruction in the program line just displayed is executed and the display then shows the result of executing that line.

For example, to execute the program stored in the calculator one line at a time:

Keystrokes	Display	
$\boxed{f} \boxed{P/R}$	124 . 25	Sets calculator to Run mode and to line 00 in program memory. (Display shown assumes results remain from previous calculation.)
625	625 .	Keys in price of typewriter.
\boxed{SST}	01-	36 Program line 01: \boxed{ENTER}
	625 . 00	Result of executing program line 01.
\boxed{SST}	02-	2 Program line 02: 2.

Keystrokes	Display
	2 . Result of executing program line 02.
[SST]	03- 5 Program line 03: 5.
	25 . Result of executing program line 03.
[SST]	04- 25 Program line 04: [%]
	156 . 25 Result of executing program line 04.
[SST]	05- 30 Program line 05: [-]
	468 . 75 Result of executing program line 05.
[SST]	06- 5 Program line 06: 5
	5 . Result of executing program line 06.
[SST]	07- 40 Program line 07: [+]
	473 . 75 Result of executing program line 07 (the last line of the program).

Pressing [9][BST] while the calculator is in Run mode sets the calculator to the previous line in program memory, then displays that line's number and the keycode of the instruction stored there, just as in Program mode. In Run mode, however, when the [BST] key is released the display again shows the same number as it did before [9][BST] was pressed: no instruction in program memory is executed.

Interrupting Program Execution

Occasionally you'll want a program to stop executing so that you can see an intermediate result or enter new data. The hp 12c provides two functions for doing so: [PSE] (*pause*) and [R/S] (*run/stop*).

Pausing During Program Execution

When a running program executes a [PSE] instruction, program execution halts for about 1 second, then resumes. During the pause, the calculator displays the last result calculated before the [PSE] instruction was executed.

If you press any key during a pause, program execution is halted indefinitely. To resume program execution at the program line following that containing the [PSE] instruction, press [R/S].

98 Section 8: Programming Basics

Example: Create a program that calculates the entries in the AMOUNT, TAX, and TOTAL columns for each item on the jewelry distributor's invoice shown on the next page, and also calculates the total in each of these columns for all items on the invoice. Assume the sales tax is $6\frac{3}{4}\%$.

To conserve lines of program memory, instead of keying in the tax rate before the $\%$ instruction we'll store it in register R_0 and recall it before the $\%$ instruction. Before storing the program in program memory, we'll calculate the required amounts for the first item on the invoice manually. The keystroke sequence will use storage register arithmetic (described on page 24) in registers R_1 , R_2 , and R_3 to calculate the column sums. Since these registers are cleared when $\text{f CLEAR}[\Sigma]$ is pressed, we'll press those keys before beginning the manual calculation — and also later, before running the program — to ensure that the column sums are "initialized" to zero. (Pressing $\text{f CLEAR}[\text{REG}]$ would clear registers R_1 through R_3 , but would also clear R_0 , which will contain the tax rate.)

DIRECT FORM PURCHASE REQUISITION ORDER
P.O. No. 25-

**RASTON, UNGER, BENTZ & YATES
JEWELERS**

2561 N.W. Morrison Ave.
New York, New York, 14203
Telephone (716) 731 - 8240

ORDER DATE _____ CONFIRMING _____ SHIP VIA: SURFACE AIR UPS
VENDOR WILL CALL OTHER

ITEM	QTY.	DESCRIPTION	UNIT PRICE	AMOUNT	TAX 6.75%	TOTAL
1	13	SS4 Star Sapphire	\$68.50	?	?	?
2	18	RG13 Ruby Ring	72.90	?	?	?
3	24	GB87 Gold Band	85.00	?	?	?
4	5	DG163 Diamond	345.00	?	?	?
5						

Pressing the \boxed{g} \boxed{PSE} keys is not necessary when we do the calculations manually, since in Run mode the result of every intermediate calculation is displayed automatically; but we'll include \boxed{PSE} instructions in the program so that the intermediate results AMOUNT and TAX are automatically displayed when the program is executed.

Keystrokes	Display	
6.75 \boxed{STO} $\boxed{0}$	6.75	Stores tax rate in R_0 .
\boxed{f} \boxed{CLEAR} $\boxed{\Sigma}$	0.00	Clears the registers in R_1 through R_6 .
13	13.	Keys in quantity of item.
\boxed{ENTER}	13.00	Separates quantity of item from cost of item to be keyed in next.
68.5	68.5	Keys in cost of item.
\boxed{X}	890.50	AMOUNT.
\boxed{STO} $\boxed{+}$ $\boxed{1}$	890.50	Adds AMOUNT to sum of AMOUNT entries in register R_1 .
\boxed{RCL} $\boxed{0}$	6.75	Recalls tax rate to display.
$\boxed{\%}$	60.11	TAX.
\boxed{STO} $\boxed{+}$ $\boxed{2}$	60.11	Adds TAX to sum of TAX entries in register R_2 .
$\boxed{+}$	950.61	TOTAL.
\boxed{STO} $\boxed{+}$ $\boxed{3}$	950.61	Adds TOTAL to sum of TOTAL entries in register R_3 .

Now, we'll store the program in program memory. Do not key in the quantity and cost of each item; these numbers will vary each time the program is run.

Keystrokes	Display	
\boxed{f} $\boxed{P/R}$	00-	Sets calculator to Program mode.
\boxed{f} \boxed{CLEAR} \boxed{PRGM}	00-	Clears program memory.
\boxed{X}	01- 20	
\boxed{g} \boxed{PSE}	02- 43 31	Pauses to display AMOUNT.
\boxed{STO} $\boxed{+}$ $\boxed{1}$	03- 44 40 1	
\boxed{RCL} $\boxed{0}$	04- 45 0	
$\boxed{\%}$	05- 25	

100 Section 8: Programming Basics

Keystrokes

g PSE

STO **+** 2

+

STO **+** 3

Display

06- 43 31 Pauses to display TAX.

07- 44 40 2

08- 40

09- 44 40 3

Now, to run the program:

Keystrokes

f P/R

f CLEAR Σ

6.75 **STO** 0

13 **ENTER** 68.5

R/S

18 **ENTER** 72.9

R/S

24 **ENTER** 85

R/S

5 **ENTER** 345

R/S

RCL 1

RCL 2

RCL 3

Display

950.61

0.00

68.5

890.50

60.11

950.61

72.9

1,312.20

88.57

1,400.77

85.

2,040.00

137.70

2,177.70

345.

1,725.00

116.44

1,841.44

5,967.70

402.82

6,370.52

Sets calculator to Run mode.

Clears registers $R_1 - R_6$.

Stores tax rate.

Enters quantity and price of first item on invoice.

AMOUNT for first item.

TAX for first item.

TOTAL for first item.

Enters quantity and price of second item on invoice.

AMOUNT for second item.

TAX for second item.

TOTAL for second item.

Enters quantity and price of third item on invoice.

AMOUNT for third item.

TAX for third item.

TOTAL for third item.

Enters quantity and price of fourth item on invoice.

AMOUNT for fourth item.

TAX for fourth item.

TOTAL for fourth item.

Sum of AMOUNT column.

Sum of TAX column.

Sum of TOTAL column.

If the duration of the pause is not long enough to write down the number displayed, you can prolong it by using more than one [PSE] instruction. Alternatively, you can have the program automatically *stop* as described next.

Stopping Program Execution

Stopping Program Execution Automatically. Program execution is automatically halted when the program executes a [R/S] instruction. To resume executing the program from the program line at which execution was halted, press [R/S].

Example: Replace the program above by one containing [R/S] instructions instead of [PSE] instructions.

Keystrokes	Display	
[f] [P/R]	00-	Sets calculator to Program mode.
[f] CLEAR [PRGM]	00-	Clears program memory.
[X]	01-	20
[R/S]	02-	31 Stops program execution to display AMOUNT.
[STO] [+] 1	03- 44 40 1	
[RCL] 0	04- 45 0	
[%]	05-	25
[R/S]	06-	31 Stops program execution to display TAX.
[STO] [+] 2	07- 44 40 2	
[+]	08-	40
[STO] [+] 3	09- 44 40 3	
[f] [P/R]	6,370.52	Sets calculator to Run mode.
[f] CLEAR [Σ]	0.00	Clears registers R ₁ through R ₆ .
13 [ENTER] 68.5	68.5	First item.
[R/S]	890.50	AMOUNT for first item.
[R/S]	60.11	TAX for first item.
[R/S]	950.61	TOTAL for first item.
18 [ENTER] 72.9	72.9	Second item.
[R/S]	1,312.20	AMOUNT for second item.
[R/S]	88.57	TAX for second item.
[R/S]	1,400.77	TOTAL for second item.

102 Section 8: Programming Basics

Keystrokes	Display	
24 \square ENTER85	85.	Third item.
\square R/S	2,040.00	AMOUNT for third item.
\square R/S	137.70	TAX for third item.
\square R/S	2,177.70	TOTAL for third item.
5 \square ENTER345	345.	Fourth item.
\square R/S	1,725.00	AMOUNT for fourth item.
\square R/S	116.44	TAX for fourth item.
\square R/S	1,841.44	TOTAL for fourth item.
\square RCL1	5,967.70	Sum of AMOUNT column.
\square RCL2	402.82	Sum of TAX column.
\square RCL3	6,370.52	Sum of TOTAL column.

Program execution is also automatically halted when the calculator overflows (refer to page 73) or attempts an improper operation that results in an **Error** display. Either of these conditions signifies that the program itself probably contains an error.

To determine at which program line execution has halted (in order to locate the error), press any key to clear the **Error** display, then press \square f \square P/R to set the calculator to Program mode and display that program line.

You may also want to display the current program line (by pressing \square f \square P/R) if your program has halted at one of several \square R/S instructions in your program and you want to determine which one that is. To continue executing the program afterward:

1. Press \square f \square P/R to set the calculator back to Run mode.
2. If you want to resume execution from the program line at which execution halted rather than from line 00, press \square g \square GTO followed by two digit keys that specify the program line desired.
3. Press \square R/S to resume execution.

Stopping Program Execution Manually. Pressing any key while a program is running halts program execution. You may want to do this if the calculated results displayed by a running program appear to be incorrect (indicating that the program itself is incorrect).

To halt program execution during a pause in a running program (that is, when \square PSE is executed), press any key.

After stopping program execution manually, you can determine at which program line execution has halted and/or resume program execution as described above.

Section 9

Branching and Looping

Although the instructions in a program normally are executed in order of their program line numbers, in some situations it is desirable to have program execution transfer or “branch” to a program line that is not the next line in program memory. Branching also makes it possible to automatically execute portions of a program more than once — a process called “looping.”

Simple Branching

The `GTO` (go to) instruction is used in a program to transfer execution to any program line. The program line desired is specified by keying its two-digit line number into the program line containing the `GTO` instruction. When the `GTO` instruction is executed, program execution branches or “goes to” the program line specified and then continues sequentially as usual.

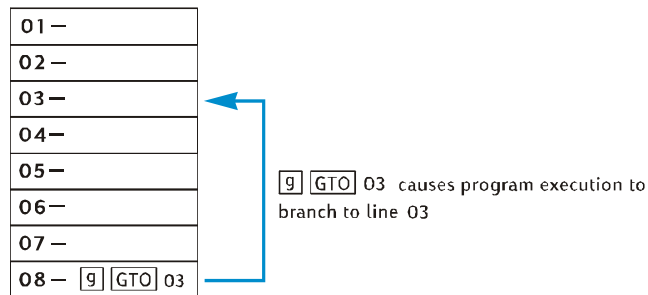

You have already seen a common use of branching: the `GTO00` instruction (that is stored in program memory after the program you key in) transfers execution to program line 00. A `GTO` instruction can be used to branch not only backward in program memory — as in the case of `GTO00` and as illustrated above — but also forward in program memory. Backward branching is typically done to create loops (as described next); forward branching is typically done in conjunction with an `X<Y` or `X=0` instruction for conditional branching (as described afterward).

104 Section 9: Branching and Looping

Looping

If a **GTO** instruction specifies a lower-numbered line in program memory, the instructions in the program lines between the specified line and the **GTO** instruction will be executed repeatedly. As can be seen in the illustration above under Simple Branching, once the program begins executing the “loop” it will execute it again and again.

If you want to terminate the execution of a loop, you can include an **x<y** or **x=0** instruction (described below) or an **R/S** instruction within the loop. You can also terminate execution by pressing any key while the loop is being executed.

Example: The following program automatically amortizes the payments on a home mortgage without requiring you to press **f** **AMORT** for each payment. It will amortize one month’s payments each time or one year’s payments each time the loop is executed, depending on whether the number 1 or 12 is in the display when you start running the program. Before running the program, we’ll “initialize” it by storing the required data in the financial registers — just as we would do if we were amortizing a single payment manually. We’ll run the program for a \$50,000 mortgage at $12\frac{3}{4}\%$ for 30 years, and we’ll key 1 into the display just before running it in order to amortize monthly payments. For the first two “passes” through the loop we’ll execute the program one line at a time, using **SST**, so that we can see the looping occurring; then we’ll use **R/S** to execute the entire loop a third time before terminating execution.

Keystrokes	Display	
f P/R	00-	Sets calculator to Program mode.
f CLEAR PRGM	00-	Clears program memory
STO 0	01- 44 0	Stores the number from the display into register R_0 . This number will be the number of payments to be amortized.

Keystrokes	Display	
<code>[RCL]0</code>	02-	45 0 Recalls the number of payments to be amortized. This program line is the one to which program execution will later branch. It is included because after the first time the loop is executed, the number in the "display"* is replaced by the result of <code>[AMORT]</code> .
<code>[f][AMORT]</code>	03-	42 11 Amortizes payment(s).
<code>[g][PSE]</code>	04-	43 31 Pauses to display amount of payment(s) applied to interest.
<code>[X↔Y]</code>	05-	34 Brings amount of payment(s) applied to principal into "display."*
<code>[g][PSE]</code>	06-	43 31 Pauses to display amount of payment(s) applied to principal.
<code>[g][GTO]02</code>	07- 43, 33	02 Transfers program execution to line 02, so that the number of payments to be amortized can be recalled to the display before the <code>[AMORT]</code> instruction in line 03 is executed.
<code>[f][P/R]</code>	0.00	Sets calculator to Run mode. (Display shown assumes no results remain from previous calculations.)
<code>[f][CLEAR][FIN]</code>	0.00	Clears financial registers.
<code>30[g][12X]</code>	360.00	Enters <i>n</i> .
<code>12.75[g][12÷]</code>	1.06	Enters <i>i</i> .
<code>50000[PV]</code>	50,000.00	Enters <i>PV</i> .
<code>[g][END]</code>	50,000.00	Sets payment to End.
<code>[PMT]</code>	-543.35	Calculates the monthly payment.
<code>0[n]</code>	0.00	Reset <i>n</i> to zero.
<code>1</code>	1.	Keys 1 into the display to amortize monthly payments.
<code>[SST]</code>	01- 44	0 Line 01: <code>[STO]0</code> .
	1.00	

* More precisely, the number in the X-register.

106 Section 9: Branching and Looping

Keystrokes	Display
[SST]	02- 45 0 Line 02: [RCL]0. This is the beginning of the first pass through the loop. 1.00
[SST]	03- 42 11 Line 03: [f] [AMORT]. -531.25 Portion of first month's payment applied to interest.
[SST]	04- 43 31 Line 04: [g] [PSE]. -531.25
[SST]	05- 34 Line 05: [x>y]. -12.10 Portion of first month's payment applied to principal.
[SST]	06- 43 31 Line 06: [g] [PSE]. -12.10
[SST]	07- 43, 33 02 Line 07: [g] [GTO]02. This is the end of the first pass through the loop. -12.10
[SST]	02- 45 0 Line 02: [RCL]0. Program execution has branched to the beginning of the loop for the second pass through it. 1.00
[SST]	03- 42 11 Line 03: [f] [AMORT]. -531.12 Portion of second month's payment applied to interest.
[SST]	04- 43 31 Line 04: [g] [PSE]. -531.12
[SST]	05- 34 Line 05: [x>y]. -12.23 Portion of second month's payment applied to principal.
[SST]	06- 43 31 Line 06: [g] [PSE]. -12.23

Keystrokes	Display	
$\boxed{\text{SST}}$	07- 43, 33	02 Line 07: $\boxed{\text{G}}\boxed{\text{GTO}}\boxed{02}$. This is the end of the second pass through the loop.
	-12.23	
$\boxed{\text{R/S}}$	-530.99	Portion of third month's payment applied to interest.
	-12.36	Portion of third month's payment applied to principal.
$\boxed{\text{R/S}}$ (or any key)	-12.36	Halts program execution.

Conditional Branching

Often there are situations when it is desirable for a program to be able to branch to different lines in program memory, depending on certain conditions. For example, a program used by an accountant to calculate taxes might need to branch to different program lines depending on the tax rate for the particular income level.

The hp 12c provides two *conditional* test instructions that are used in programs for conditional branching:

- $\boxed{\text{x}\leq\text{y}}$ tests whether the number in the X-register (represented by the x in the key symbol) is less than or equal to the number in the Y-register (represented by the y in the key symbol). As discussed in Appendix A, the number in the X-register is simply the number that would, if the calculator were in Run mode, be currently in the display; and the number in the Y-register is the number that would, if the calculator were in Run mode, have been in the display when $\boxed{\text{ENTER}}$ was pressed. For example, pressing $4\boxed{\text{ENTER}}5$ would place the number 4 in the Y-register and the number 5 in the X-register.
- $\boxed{\text{x}=0}$ tests whether the number in the X-register is equal to zero.

The possible results of executing either of these instructions are:

- If the condition tested for is true when the instruction is executed, program execution continues sequentially with the instruction in the next line of program memory.
- If the condition tested for is false when the instruction is executed, program execution skips the instruction in the next line of program memory and continues with the instruction in the following line.

These rules can be summarized as "DO if TRUE".

108 Section 9: Branching and Looping

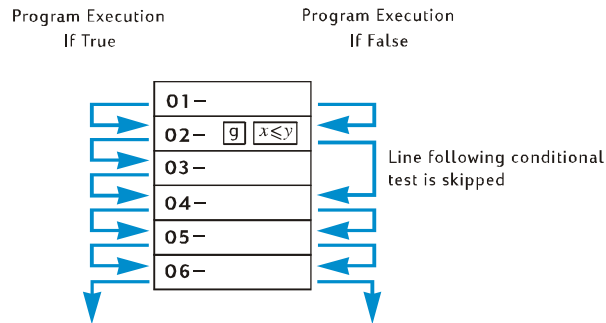

The program line immediately following that containing the conditional test instruction can contain any instruction; however, the most commonly used instruction there is `GTO`. If a `GTO` instruction follows a conditional test instruction, program execution branches elsewhere in program memory if the condition is true and continues with the next line in program memory if the condition is false.

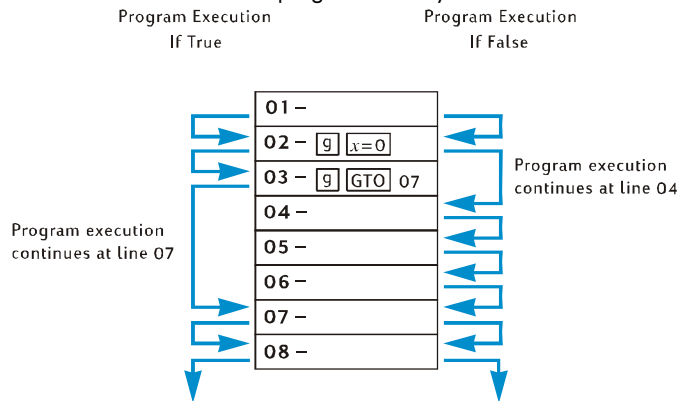

Example: The following program calculates income tax at a rate of 20% on incomes of \$20,000 or less and 25% on incomes of more than \$20,000. To conserve program lines, the program assumes that the test value — 20,000 — has been stored in register R_0 and the tax rates — 20 and 25 — have been stored in registers R_1 and R_2 , respectively.

Note: If a program requires that certain numbers be in the X- and Y-registers when instructions such as `x <= y` are executed, it is extremely helpful when writing the program to show the quantities in each register after each instruction is executed, as in the following diagram.

Y →	0	income	20,000	20,000	20,000
X →	income	20,000	income	income	income
Keys →	income	$\boxed{\text{RCL}} \boxed{0}$	$\boxed{x \geq y}$	$\boxed{x \leq y}$	$\boxed{\text{GTO}} \boxed{07}$
Line →		01	02	03	04

Y →	income	income	income	income
X →	25.00	25.00	20.00	tax
Keys →	$\boxed{\text{RCL}} \boxed{2}$	$\boxed{\text{GTO}} \boxed{08}$	$\boxed{\text{RCL}} \boxed{1}$	$\boxed{\%}$
Line →	05	06	07	08

We'll key the income into the display before running the program so that it will be in the X-register when the $\boxed{\text{RCL}} \boxed{0}$ instruction in program line 01 is executed. This instruction will place the test value 20,000 in the X-register and (as explained in Appendix A) move the income into the Y-register. The $\boxed{x \geq y}$ instruction in program line 02 will exchange the numbers in the X- and Y-registers (as also explained in Appendix A): that is, it will place the income back into the X-register and place the test value into the Y-register. This is necessary because when either the $\boxed{\text{RCL}} \boxed{2}$ instruction in line 05 or the $\boxed{\text{RCL}} \boxed{1}$ instruction in line 07 is executed, the number in the X-register is moved into the Y-register; if the $\boxed{x \geq y}$ instruction were not included, the test value 20,000, rather than the income, would be in the Y-register when the $\boxed{\%}$ instruction in line 08 is executed.

Keystrokes

Display

\boxed{f} $\boxed{\text{P/R}}$	07- 43, 33	02	Sets calculator to Program mode. (Display shows program line at which execution was halted at end of preceding example.)
\boxed{f} $\boxed{\text{CLEAR}}$ $\boxed{\text{PRGM}}$	00-		Clears program memory.
$\boxed{\text{RCL}} \boxed{0}$	01- 45	0	Recalls test value into X-register and places income in Y-register.
$\boxed{x \geq y}$	02-	34	Places income in X-register and test value in Y-register.
\boxed{g} $\boxed{x \leq y}$	03- 43	34	Tests whether number in X-register (income) is less than or equal to number in Y-register (20,000).

110 Section 9: Branching and Looping

Keystrokes	Display	
$\boxed{9} \boxed{GTO} 07$	04- 43, 33	07 If condition is true, branches to program line 07.
$\boxed{RCL} 2$	05- 45	2 If condition is false, recalls 25% tax rate to X-register.
$\boxed{9} \boxed{GTO} 08$	06- 43, 33	08 Branches to program line 08.
$\boxed{RCL} 1$	07- 45	1 Recalls 20% tax rate to X-register.
$\boxed{\%}$	08-	25 Calculates tax.
$\boxed{f} \boxed{P/R}$	-12.36	Sets calculator to Run mode. (Display shows results of running of previous program.)

Now, we'll store the required numbers in registers R_0 , R_1 , and R_2 , then we'll run the program, using \boxed{SST} so that we can check that the branching occurs properly. It's good practice with programs containing conditional test instructions to check that the program branches correctly for all possible conditions: in this case, if the income is less than, equal to, or greater than the test value.

Keystrokes	Display	
20000 $\boxed{STO} 0$	20,000.00	Stores test value in register R_0 .
20 $\boxed{STO} 1$	20.00	Stores 20% tax rate in register R_1 .
25 $\boxed{STO} 2$	25.00	Stores 25% tax rate in register R_2 .
15000	15,000.	Keys income less than test value into display and X-register.
\boxed{SST}	01- 45 20,000.00	0 Line 01: $\boxed{RCL} 0$. Test value has been recalled to X-register, moving income to Y-register.
\boxed{SST}	02- 34 15,000.00	34 Line 02: $\boxed{X\leftrightarrow Y}$ Income has been placed in X-register and test value has been placed in Y-register.
\boxed{SST}	03- 43 15,000.00	34 Line 03: $\boxed{9} \boxed{X\leq Y}$
\boxed{SST}	04- 43, 33	07 Condition tested by $\boxed{X\leq Y}$ was true, so program execution continued with line 04: $\boxed{9} \boxed{GTO} 07$.

Keystrokes	Display
	15,000.00
[SST]	07- 45 1 Line 07: [RCL]1. 20.00 20% tax rate has been recalled to X-register, moving income to Y-register.
[SST]	08- 25 Line 08: [%]. 3,000.00 20% of 15,000 = 3,000.
20000	20,000. Keys income equal to test value into display and X-register.
[SST]	01- 45 0 Line 01: [RCL]0. 20,000.00 Test value has been recalled to X-register, moving income to Y-register.
[SST]	02- 34 Line 02: [X \leftrightarrow Y]. 20,000.00 Income has been placed in X-register and test value has been placed in Y-register.
[SST]	03- 43 34 Line 03 [g][X \leq Y]. 20,000.00
[SST]	04- 43, 33 07 Condition tested by [X \leq Y] was true, so program execution continued with line 04: [g][GTO]07. 20,000.00
[SST]	07- 45 1 Line 07: [RCL]1. 20.00 20% tax rate has been recalled to X-register, moving income to Y-register.
[SST]	08- 25 Line 08: [%]. 4,000.00 20% of 20,000 = 4,000.
25000	25,000. Keys income greater than test value into display and X-register.
[SST]	01- 45 0 Line 01: [RCL]0. 20,000.00 Test value has been recalled to X-register, moving income to Y-register.

112 Section 9: Branching and Looping

Keystrokes	Display
[SST]	02- 34 Line 02: [X≠Y]. 25,000.00 Income has been placed in X-register and test value has been placed in Y-register.
[SST]	03- 43 34 Line 03: [9][X≠Y]. 25,000.00
[SST]	05- 45 2 Condition tested by [X≠Y] was false, so program execution skipped the next line and continued at line 05: [RCL]2. 25.00 25% tax rate has been recalled to X-register, moving income to Y-register.
[SST]	06- 43, 33 08 Line 06: [9][GTO]08. 25.00
[SST]	08- 25 Line 08: [%]. 6,250.00 25% of 25,000 = 6,250.

Section 10

Program Editing

There are various reasons why you might want to modify a program you have stored in Program memory: to correct a program that turns out to have errors; to insert new instructions such as $\boxed{\text{STO}}$ to store intermediate results or $\boxed{\text{PSE}}$ to display intermediate results; or to replace a $\boxed{\text{PSE}}$ instruction by an $\boxed{\text{R/S}}$ instruction.

Rather than clearing program memory and keying in the modified program, you can modify the program already stored in the calculator. This is called *program editing*.

Changing the Instruction in a Program Line

To change a single instruction in program memory:

1. Press $\boxed{\text{f}} \boxed{\text{P/R}}$ to set the calculator to Program mode.
2. Use $\boxed{\text{SST}}$, $\boxed{\text{BST}}$, or $\boxed{\text{GTO}} \boxed{\cdot}$ to set the calculator to the program line *preceding* the line containing the instruction to be changed.
3. Key in the new instruction.

For example, to change the instruction stored in program line 05, press $\boxed{\text{g}} \boxed{\text{GTO}} \boxed{\cdot} \boxed{04}$, then key in the new instruction that is to be stored in program line 05. The instruction previously stored in line 05 will be replaced; it is *not* automatically “bumped” into line 06.

Example: With the last program from the preceding section still stored in the calculator, suppose you wanted to use register R_2 for some other purpose, and so you needed to replace the $\boxed{\text{RCL}} \boxed{2}$ instruction in program line 05 with, say, $\boxed{\text{RCL}} \boxed{6}$. You could change the instruction in line 05 as follows:

Keystrokes	Display	
$\boxed{\text{f}} \boxed{\text{P/R}}$	00-	Sets calculator to Program mode.
$\boxed{\text{g}} \boxed{\text{GTO}} \boxed{\cdot} \boxed{04}$	04- 43, 33	07 Sets calculator to program line preceding that containing the instruction to be changed.
$\boxed{\text{RCL}} \boxed{6}$	05- 45	6 Keys new instruction into program line 05, replacing the $\boxed{\text{RCL}} \boxed{2}$ instruction previously there.
$\boxed{\text{SST}}$	06- 43, 33	08 Shows that instruction in program line 06 has not been changed.

114 Section 10: Program Editing

Keystrokes	Display	
\boxed{f} $\boxed{P/R}$	6,250.00	Sets calculator back to Run mode. (Display shown assumes results remain from last example in preceding section.)
\boxed{RCL} $\boxed{2}$ \boxed{STO} $\boxed{6}$	25.00	Copies tax rate from R_2 into R_6 .

Adding Instructions at the End of a Program

To add one or more instructions at the end of the last program stored in program memory:

1. Press \boxed{f} $\boxed{P/R}$ to set the calculator to Program mode.
2. Press \boxed{g} \boxed{GTO} $\boxed{\cdot}$ followed by two digits that specify the *last* line you keyed into program memory (that is, the highest numbered line, not necessarily the line most recently keyed in).
3. Key in the new instruction or instructions.

Note: To add one or more instructions at the end of a program that is not the *last* program stored in program memory, use the procedure described below under Adding Instructions Within a Program.

Example: With the last program from the preceding section stored in the calculator, suppose you wanted to add a $\boxed{-}$ instruction at the end in order to calculate the net income after taxes. You could do so as follows:

Keystrokes	Display	
\boxed{f} $\boxed{P/R}$	00-	Sets calculator to Program mode.
\boxed{g} \boxed{GTO} $\boxed{\cdot}$ $\boxed{08}$	08-	25 Sets calculator to last line keyed into program memory.
$\boxed{-}$	09-	30 Keys new instruction into program line 09.
\boxed{f} $\boxed{P/R}$	25.00	Sets calculator back to Run mode.
15000 $\boxed{R/S}$	12,000.00	Net income after 20% tax is subtracted from \$15,000 income.

Adding Instructions Within a Program

If an instruction is to be added within a program, simply keying it in will replace the instruction previously stored in that program line, as described above; the contents of all higher-numbered program lines remain unchanged.

To add instructions within a program, you could simply key in the new instructions, beginning at the proper program line, followed by the original instructions from that program line through the end of the program. This method is described below under Adding Instructions by Replacement. When instructions must be added in the middle of a long program, however, using this method will require you to key in numerous instructions — namely, the original instructions from the point at which the new instructions are added through the end of program memory. Since keying in these instructions may require a significant amount of time, in such situations you may prefer to use the method described below under Adding Instructions by Branching.

That method basically involves branching to the new instructions which are stored at the end of program memory, then branching back to the program line immediately following the line from which you branched out. Adding instructions by branching is not so simple as adding instructions by replacement; however, it generally will require fewer keystrokes whenever there are more than four program lines between (and including) the first line to be executed after the new instruction(s) and the last line you keyed into program memory. Furthermore, if program memory includes branches to program lines following the point at which the new instruction(s) are being added, adding instructions by branching will *not* require that you change the line numbers specified in the `GTO` instructions, which *may* be necessary when you add instructions by replacement.

Adding Instructions by Replacement

1. Press `f P/R` to set the calculator to Program mode.
2. Press `g GTO .` followed by two digits that specify the last program line to be executed before the added instruction(s). This sets the calculator to the proper program line for adding the new instruction(s) in the next step.
3. Key in the new instruction or instructions.
4. Key in the original instruction or instructions, beginning with the first instruction to be executed *after* the added instruction(s), and continuing through the last instruction you keyed into program memory.

Note: If program memory includes branches to program lines following that at which the first new instruction is being added, remember to change the line number(s) specified in the `GTO` instruction(s) — as described above under Changing the Instruction in a Program Line — to the actual *new* line number(s).

116 Section 10: Program Editing

Example: Assuming you have added a $\boxed{-}$ instruction at the end of program memory as in the preceding example, suppose you now wanted to insert an $\boxed{R/S}$ instruction before the $\boxed{-}$ instruction so that the program will display the amount of the tax before displaying the net income after tax. Since there is only one instruction ($\boxed{-}$) following the point at which the new instruction is being added, it is simplest to add the $\boxed{R/S}$ instruction by replacement, as follows:

Keystrokes	Display	
$\boxed{f} \boxed{P/R}$	00-	Sets calculator to Program mode.
$\boxed{9} \boxed{GTO} \boxed{\cdot} \boxed{08}$	08-	25 Sets calculator to last program line to be executed, which contains the $\boxed{\%}$ instruction.
$\boxed{R/S}$	09-	31 Keys in new instruction.
$\boxed{-}$	10-	30 Keys in original instruction, which was replaced by new instruction added.
$\boxed{f} \boxed{P/R}$	12,000.00	Sets calculator back to Run mode.
15000 $\boxed{R/S}$	3,000.00	Twenty percent tax on \$15,000 income.
$\boxed{R/S}$	12,000.00	Net income after tax.

Adding Instructions by Branching

1. Press $\boxed{f} \boxed{P/R}$ to set the calculator to Program mode.
2. Press $\boxed{9} \boxed{GTO} \boxed{\cdot}$ followed by two digits that specify the program line immediately preceding the point at which the new instruction(s) are being added — usually, the last program line to be executed before the added instruction(s). This sets the calculator to the proper program line for inserting a \boxed{GTO} instruction in the next step. This \boxed{GTO} instruction will replace whatever instruction was already stored there, but that instruction will be keyed back into program memory, to be executed just after the new instructions, in step 7.
3. Press $\boxed{9} \boxed{GTO}$ followed by two digits that specify the *second* line after the last line you keyed into program memory. (Branching to the *second* line rather than to the *first* is necessary because the first line following the last program in program memory must contain a $\boxed{GTO}00$ instruction. The $\boxed{GTO}00$ instruction ensures that program execution will branch to line 00 and halt after the program is run.) For example, if the last line you keyed into program memory was line 10, you would press $\boxed{9} \boxed{GTO}12$ at this step, preserving the $\boxed{9} \boxed{GTO}00$ in line 11.
4. Press $\boxed{9} \boxed{GTO} \boxed{\cdot}$ followed by two digits that specify the last line you keyed into program memory.

5. Press $\boxed{9}\boxed{GTO}\boxed{00}$. This automatically converts a data storage register into seven additional lines of program memory (if there was not already a $\boxed{GTO}\boxed{00}$ instruction remaining at the end of program memory), and it ensures that program execution will branch to line 00 after the program is run.
6. Key in the instruction(s) being added.
7. Key in the instruction that originally immediately followed the point at which the new instruction(s) are being added — that is, the first instruction to be executed *after* the added instruction(s). (This instruction was replaced by the \boxed{GTO} instruction keyed in at step 3.)
8. Press $\boxed{9}\boxed{GTO}$ followed by two digits that specify the *second* line following the point at which the new instruction(s) are being added. This \boxed{GTO} instruction will cause program execution to branch back to the proper line within the original program.

Example: Continuing with the preceding example, suppose incomes less than or equal to \$7,500 were not to be taxed. You could modify the program to check for this condition and stop at line 00, displaying the original income keyed in, by storing 7,500 in register R_3 and adding the following instructions between lines 00 and 01: $\boxed{RCL}\boxed{3}\boxed{\times\div}\boxed{9}\boxed{\times\div}\boxed{9}\boxed{GTO}\boxed{00}$. Since there are more than four instructions between (and including) the first line to be executed after the added instructions (line 01) and the last line you keyed into program memory (line 10), it will require fewer keystrokes to add the new instructions by branching than to add them by replacement.

Keystrokes	Display		
$\boxed{f}\boxed{P/R}$	00-		Sets calculator to Program mode.
$\boxed{9}\boxed{GTO}\boxed{\cdot}\boxed{00}$	00-		Sets calculator to program line immediately preceding point at which new instructions are being added. (In this particular example, this step could have been skipped since calculator was already set at the proper program line.)
$\boxed{9}\boxed{GTO}\boxed{12}$	01- 43, 33	12	Branches to program line 12, the second line after last line of program.
$\boxed{9}\boxed{GTO}\boxed{\cdot}\boxed{10}$	10-	30	Sets calculator to last line of program so that $\boxed{GTO}\boxed{00}$ instruction keyed in next will be stored in first line following program.
$\boxed{9}\boxed{GTO}\boxed{00}$	11- 43, 33	00	Ensures that $\boxed{GTO}\boxed{00}$ instruction follows program.

118 Section 10: Program Editing

Keystrokes	Display	
$\boxed{\text{RCL}}\boxed{3}$	12- 45 3	} Added instructions.
$\boxed{\times}\boxed{\div}$	13- 34	
$\boxed{\text{g}}\boxed{\text{x}\leq\text{y}}$	14- 43 34	
$\boxed{\text{g}}\boxed{\text{GTO}}\boxed{00}$	15- 43, 33 00	
$\boxed{\text{RCL}}\boxed{0}$	16- 45 0	Keys in instruction immediately following point at which new instructions are being added. (This instruction was replaced in line 01 by $\boxed{\text{GTO}}\boxed{12}$ instruction.)
$\boxed{\text{g}}\boxed{\text{GTO}}\boxed{02}$	17- 43, 33 02	Branches back to second line (line 02) following point at which new instructions are being added.
$\boxed{\text{f}}\boxed{\text{P/R}}$	12,000.00	Sets calculator back to Run mode.
7500 $\boxed{\text{STO}}\boxed{3}$	7,500.00	Stores test value in register R ₃ .
6500 $\boxed{\text{R/S}}$	6,500.00	Runs program for income less than \$7,500. Display shows original income keyed in, indicating that tax is zero.
15000 $\boxed{\text{R/S}}$	3,000.00	Tax on \$15,000 income.
$\boxed{\text{R/S}}$	12,000.00	Net income after tax. This shows program still works for an income greater than \$7,500 and less than \$20,000.

The following illustration of the edited program shows how program execution branches to the instructions added at the end of program memory, then branches back.

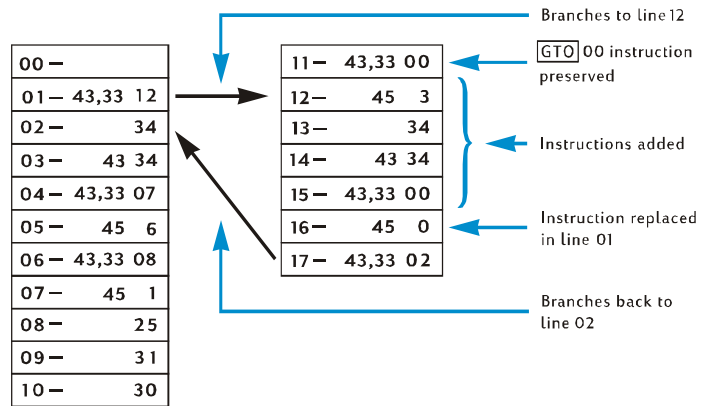

Section 11

Multiple Programs

You can store multiple programs in program memory, provided that you separate them by instructions that will halt program execution after each program is run and return to the beginning of the program if it is run again. You can run programs after the first one stored in program memory by setting the calculator to the first line of the program using $\overline{\text{GTO}}$ before pressing $\overline{\text{R/S}}$.

Storing Another Program

To store a program after another program is already stored in program memory:

1. Press $\overline{\text{f}} \overline{\text{P/R}}$ to set the calculator to Program mode. Do *not* clear program memory.
2. Press $\overline{\text{9}} \overline{\text{GTO}} \overline{\text{•}}$ followed by two digits that specify the number of the last line you keyed into program memory.

Note: If this is the second program to be stored in program memory, you will need to ensure that a $\overline{\text{GTO}}00$ instruction separates it from the first program by doing step 3. If there are already two or more programs stored in program memory, skip step 3 and proceed with step 4.

3. Press $\overline{\text{9}} \overline{\text{GTO}}00$. This automatically converts a data storage register into seven additional lines of program memory (if there was not already a $\overline{\text{GTO}}00$ instruction remaining at the end of program memory), and it ensures that program execution will branch to line 00 after the first program is run.
4. Key the program into program memory. If you are storing a program that you originally had written to be stored at the beginning of program memory and the program contains a $\overline{\text{GTO}}$ instruction, be sure to change the line number specified in the instruction so that the program will branch to the actual new line number.

Note: The next two steps are included so that program execution will halt after this program is run and will return to the beginning of the program if it is run again. If the program ends with a loop, you should skip steps 5 and 6 since the instructions in those steps would serve no purpose and never be executed.

5. Press $\overline{\text{R/S}}$. This halts program execution at the end of the program.
6. Press $\overline{\text{9}} \overline{\text{GTO}}$ followed by two digit keys that specify the first line number of your new program. This transfers program execution to the beginning of the new program when the program is run again.

Example 1: Assuming that program memory still contains the last program from the preceding section (which consisted of 17 program lines), store after that program the office-supplies program from Section 8 (page 88). Since this is the second program to be stored in program memory, we'll ensure that a `GTO00` instruction separates it from the first program by doing step 3 in the procedure above. Furthermore, since this program does not end with a loop, we'll do steps 5 and 6 too.

Keystrokes	Display	
<code>f</code> <code>P/R</code>	00-	Sets calculator to Program mode.
<code>g</code> <code>GTO</code> <code>.</code> <code>17</code>	17- 43, 33	02 Sets calculator to last line keyed into program memory.
<code>g</code> <code>GTO</code> <code>00</code>	18- 43, 33	00 Ensures that second program is separated from first by <code>GTO00</code> .
<code>ENTER</code>	19-	36
2	20-	2
5	21-	5
<code>%</code>	22-	25
<code>-</code>	23-	30
5	24-	5
<code>+</code>	25-	40
<code>R/S</code>	26-	31 Halts program execution.
<code>g</code> <code>GTO</code> <code>19</code>	27- 43, 33	19 Branches to beginning of program.
<code>f</code> <code>P/R</code>	12,000.00	Sets calculator back to Run mode. (Display shown assumes results remain from running program in previous example.)

} Keys in program.

122 Section 11: Multiple Programs

Example 2: With the two programs now stored in program memory from the preceding examples (occupying 27 program lines), store the amortization program from Section 9 (page 103). Since there are already two programs stored in program memory, we'll skip step 3 in the procedure above. Furthermore, since the amortization program ends with a loop, we'll skip steps 5 and 6. When the amortization program was stored at the beginning of program memory, the **GTO** instruction at the end of the program branched to the **RCL** 0 instruction in line 02. Since the **RCL** 0 instruction is now in line 29, we'll specify that line number with the **GTO** instruction in line 34.

Keystrokes	Display	
f P/R	00-	Sets calculator to Program mode.
g GTO • 27	27- 43, 33 19	Sets calculator to last line keyed into program memory.
STO 0	28- 44 0	} Keys in program
RCL 0	29- 45 0	
f AMORT	30- 42 11	
g PSE	31- 43 31	
X↔Y	32- 34	
g PSE	33- 43 31	
g GTO 29	34- 43, 33 29	

Running Another Program

To run a program that does not begin with program line 01:

1. Press **f** **P/R** to set the calculator to Run mode. If the calculator is already in Run mode, skip this step.
2. Press **g** **GTO** followed by two digits that specify the first line of the program.
3. Press **R/S**.

Example: Run the office-supplies program, now stored in the calculator beginning at program line 19, for the typewriter listing for \$625.

Keystrokes	Display	
f P/R	12,000.00	Sets calculator to Program mode.
g GTO 19	12,000.00	Sets calculator to first line of program to be executed.
625 R/S	473.75	Net cost of typewriter.

Part III

Solutions

Section 12

Real Estate and Lending

Annual Percentage Rate Calculations With Fees

Borrowers are usually charged fees in connection with the issuance of a mortgage, which effectively raises the interest rate. The actual amount received by the borrower (PV) is reduced, while the periodic payments remain the same. Given the life or term of the mortgage, the interest rate, the mortgage amount, and the basis of the fee charge (how the fee is calculated), the true Annual Percentage Rate (APR) may be calculated. Information is entered as follows:

1. Press **g** **END** and **f** **CLEAR** **FIN**.
2. Calculate and enter the periodic payment amount of the loan.
 - a. Key in the total number of payment periods; press **n**.
 - b. Key in the periodic interest rate (as a percentage); press **i**.
 - c. Key in the mortgage amount; press **PV**.*
 - d. To obtain the periodic payment amount, press **PMT**.*
3. Calculate and key in the actual net amount disbursed.*
 - If fees are stated as a percentage of the mortgage amount (points), recall the mortgage amount (**RCL** **PV**) key in the fee (percentage) rate; press **%** **=** **PV**.
 - If fees are stated as a flat charge, recall the mortgage amount (**RCL** **PV**); key in the fee amount (flat charge); press **=** **PV**.
 - If fees are stated as a percentage of the mortgage amount plus a flat charge, recall the mortgage amount (**RCL** **PV**); key in the fee (percentage) rate, press **%** **=**; key in the fee amount (flat charge); press **=** **PV**.
4. Press **i** to obtain the interest rate per compounding period.
5. To obtain the annual nominal percentage rate, key in the number of periods per year, then press **X**.

* Positive for cash received; negative for cash paid out.

Example 1: A borrower is charged 2 points for the issuance of his mortgage. If the mortgage amount is \$60,000 for 30 years and the interest rate is $11\frac{1}{2}\%$ per year, with monthly payments, what true annual percentage rate is the borrower paying? (One point is equal to 1% of the mortgage amount.)

Keystrokes	Display	
\boxed{g} \boxed{END}		
\boxed{f} \boxed{CLEAR} \boxed{FIN}		
30 \boxed{g} $\boxed{12X}$	360.00	Months (into n)
11.5 \boxed{g} $\boxed{12\div}$	0.96	Percent monthly interest rate (into i).
60000 \boxed{PV}	60,000.00	Loan amount (into PV).
\boxed{PMT}	-594.17	Monthly payment (calculated).
\boxed{RCL} \boxed{PV} 2 $\boxed{\%}$ $\boxed{-}$ \boxed{PV}	58,800.00	Actual amount received by borrower (into PV).
\boxed{i}	0.98	Percent monthly interest rate (calculated).
12 \boxed{X}	11.76	Annual percentage rate.

Example 2: Using the same information as given in example 1, calculate the APR if the mortgage fee is \$150 instead of a percentage.

Keystrokes	Display	
\boxed{g} \boxed{END}		
\boxed{f} \boxed{CLEAR} \boxed{FIN}		
30 \boxed{g} $\boxed{12X}$	360.00	Months (into n)
11.5 \boxed{g} $\boxed{12\div}$	0.96	Percent monthly interest rate (into i).
60000 \boxed{PV}	60,000.00	Loan amount (into PV).
\boxed{PMT}	-594.17	Monthly payment (calculated).
\boxed{RCL} \boxed{PV} 150 $\boxed{-}$ \boxed{PV}	59,850.00	Effective mortgage amount (into PV).
\boxed{i}	0.96	Monthly interest rate (calculated).
12 \boxed{X}	11.53	Annual percentage rate.

126 Section 12: Real Estate and Lending

Example 3: Again using the information given in example 1, what is the APR if the mortgage fee is stated as 2 points plus \$150?

Keystrokes	Display	
g END		
f CLEAR FIN		
30 g 12x	360.00	Months (into n)
11.5 g 12÷	0.96	Percent monthly interest rate (into i).
60000 PV	60,000.00	Loan amount (into PV).
PMT	-594.17	Monthly payment (calculated).
RCL PV 2 % -	58,800.00	
150 - PV	58,650.00	Effective mortgage amount (into PV).
i	0.98	Monthly interest rate (calculated).
12 x	11.80	Annual percentage rate.

Price of a Mortgage Traded at a Discount or Premium

Mortgages may be bought and/or sold at prices lower (discounted) or higher (at a premium) than the remaining balance of the loan at the time of purchase. Given the amount of the mortgage, the periodic payment, the timing and amount of the balloon or prepayment, and the *desired* yield rate, the price of the mortgage may be found. It should be noted that the balloon payment amount (if it exists) occurs coincident with, and does not include, the last periodic payment amount.

Information is entered as follows:

1. Press **g** **END** and **f** **CLEAR** **FIN**.
2. Key in the total number of periods until the balloon payment or prepayment occurs; press **n**. (If there is no balloon payment, key in total number of payments and press **n**.)
3. Key in the desired periodic interest rate (yield) and press **i**.
4. Key in the periodic payment amount; press **PMT**.*
5. Key in the balloon payment amount and press **FV**.* (If there is no balloon payment, go to step 6.)
6. Press **PV** to obtain the purchase price of the mortgage.

* Positive for cash received; negative for cash paid out.

Example 1: A lender wishes to induce the borrower to prepay a low interest rate loan. The interest rate is 5% with 72 payments remaining of \$137.17 and a balloon payment at the end of the sixth year of \$2000. If the lender is willing to discount the future payments at 9%, how much would the borrower need to prepay the note?

Keystrokes	Display	
<input type="button" value="g"/> <input type="button" value="END"/>		
<input type="button" value="f"/> <input type="button" value="CLEAR"/> <input type="button" value="FIN"/>		
72 <input type="button" value="n"/>	72 . 00	Months (into n).
9 <input type="button" value="g"/> <input type="button" value="12"/> <input type="button" value="÷"/>	0 . 75	Discount rate (into i).
137.17 <input type="button" value="PMT"/> *	137 . 17	Monthly payments (into PMT).
2000 <input type="button" value="FV"/> <input type="button" value="PV"/>	-8 , 777 . 61	Amount necessary to prepay the note.

Example 2: A $9\frac{1}{2}\%$ mortgage with 26 years remaining and a remaining balance of \$49,350 is available for purchase. Determine the price to pay for this mortgage if the desired yield is 12%. (Since the payment amount is not given, it must be calculated.)

Keystrokes	Display	
<input type="button" value="g"/> <input type="button" value="END"/>		
<input type="button" value="f"/> <input type="button" value="CLEAR"/> <input type="button" value="FIN"/>		
26 <input type="button" value="g"/> <input type="button" value="12"/> <input type="button" value="X"/>	312 . 00	Months (into n).
9.5 <input type="button" value="g"/> <input type="button" value="12"/> <input type="button" value="÷"/>	0 . 79	Percent monthly interest rate (into i).
49350 <input type="button" value="CHS"/> <input type="button" value="PV"/> <input type="button" value="PMT"/>	427 . 17	Monthly payment to be received (calculated).
12 <input type="button" value="g"/> <input type="button" value="12"/> <input type="button" value="÷"/>	1 . 00	Desired monthly interest rate (into i).
<input type="button" value="PV"/>	-40 , 801 . 57	Purchase price to achieve the desired yield (calculated).

* Note that the payments are positive because this problem is seen from the viewpoint of the lender who will be receiving payments. The negative PV indicates money that was lent out.

Yield of a Mortgage Traded at a Discount or Premium

The annual yield of a mortgage bought at a discount or premium can be calculated given the original mortgage amount, interest rate, and periodic payment, as well as the number of payment periods per year, the price paid for the mortgage, and the balloon payment amount (if it exists).

Information is entered as follows:

1. Press **g** **END** and **f** **CLEAR** **FIN**.
2. Key in the total number of periods until the balloon payment occurs and press **n**. (If there is no balloon payment, key in the total number of periods and press **n**.)
3. Key in the periodic payment amount then press **PMT**.*
4. Key in the purchase price of the mortgage then press **PV**.*
5. Key in the balloon payment amount then press **FV**.* (If there is no balloon payment, go to step 6.)
6. Press **i** to obtain the yield per period.
7. Key in the number of periods per year and press **X** to obtain the nominal annual yield.

Example 1: An investor wishes to purchase a \$100,000 mortgage taken out at 9% for 21 years. Since the mortgage was issued, 42 monthly payments have been made. What would be the annual yield if the purchase price of the mortgage is \$79,000? (Since PMT was not given, it must be calculated).

Keystrokes	Display	
g END		
f CLEAR FIN		
21 g 12X	252.00	Enter the number of periods (into n).
9 g 12÷	0.75	Monthly interest rate (into i).
100000 CHS PV	-100,000.00	Mortgage amount (into PV ; negative to indicate money paid out).
PMT	884.58	Payment received (calculated).
RCL n	252.00	Recall number of periods.
42 - n	210.00	Number of periods left after mortgage is bought (into n).

* Positive for cash received; negative for cash paid out.

Keystrokes	Display	
79000 [CHS] [PV]	-79,000.00	Input price of mortgage (into PV; negative to indicate money paid out).
[i]	0.97	Yield per month (calculated).
12 [X]	11.68	Percent annual yield.

Example 2: Using the same information given in example 1, calculate the annual yield if the loan is to be paid in full at the end of the fifth year (from original issuance). (In this case both the payment amount and the balloon must be calculated since they are not given.)

Keystrokes	Display	
[g] [END]		
[f] [CLEAR] [FIN]		
21 [g] [12X]	252.00	Input the number of periods (into n).
9 [g] [12÷]	0.75	Monthly interest rate (into PV).
100000 [CHS] [PV]	-100,000.00	Mortgage amount (into PV).
[PMT]	884.58	Payment (calculated).

Calculate the remaining balance of the loan after five years.

5 [g] [12X]	60.00	Number of periods to be amortized.
[FV]	89,849.34	Remaining balance of the loan after five years.
[RCL] [n]	60.00	
42 [-] [n]	18.00	New life of loan.
79000 [CHS] [PV] [i]	1.77	Percent monthly yield. (calculated).
12 [X]	21.29	Percent annual yield.

The Rent or Buy Decision

The question of whether to rent or purchase a residence is not always easy to answer, especially when the time period over which you would own or rent a house is short. This program performs an analysis which could be helpful in reaching a decision. Essentially, it calculates a yield or rate of return on the proposed investment. This yield may be compared with the yield obtained by renting a residence and investing the down payment and monthly payment differences in a savings account or other investment opportunity. This program takes into account the tax advantages obtained by a home owner on property taxes and mortgage interest.

First the program computes the Net Cash Proceeds upon Resale (*NCPR*),* next the yield on the investment in the house and then the value of the hypothetical savings account at the end of the investment period. A comparison of the *NCPR* and the final balance of the savings account and a comparison of the yields should aid in determining whether to rent or buy.

KEYSTROKES	DISPLAY	KEYSTROKES	DISPLAY
f P/R		FV	33- 15
f CLEAR PRGM	00-	R/S	34- 31
FV	01- 15	R↓	35- 33
FV †	02- 15	RCL n	36- 45 11
RCL 7	03- 45 7	÷	37- 10
%	04- 25	RCL 4	38- 45 4
-	05- 30	-	39- 30
RCL n	06- 45 11	RCL . 0	40-45 48 0
STO 0	07- 44 0	%	41- 25
RCL PV	08- 45 13	RCL PMT	42- 45 14
f CLEAR FIN	09- 42 34	RCL 4	43- 45 4

* The Net Cash Proceeds upon Resale (*NCPR* = sales price – commission – mortgage balance), is the pre-tax proceeds. The program assumes that the buyer reinvests in like property and is not subject to capital gains tax.

† FV is repeated in the program twice to ensure that it is computed and not stored.

Section 12: Real Estate and Lending 131

KEYSTROKES	DISPLAY	KEYSTROKES	DISPLAY
RCL 1	10- 45 1	[-]	44- 30
[-]	11- 30	RCL 5	45- 45 5
PV	12- 13	[-]	46- 30
RCL 3	13- 45 3	RCL 8	47- 45 8
g 12÷	14- 43 12	[+]	48- 40
RCL 2	15- 45 2	[-]	49- 30
g 12X	16- 43 11	CHS	50- 16
PMT	17- 14	PMT	51- 14
R↓	18- 33	RCL 0	52- 45 0
R↓	19- 33	g 12X	53- 43 11
0	20- 0	RCL 1	54- 45 1
n	21- 11	RCL 6	55- 45 6
RCL 0	22- 45 0	[+]	56- 40
1	23- 1	CHS	57- 16
2	24- 2	PV	58- 13
X	25- 20	i	59- 12
f AMORT	26- 42 11	RCL g 12÷	60-45 43 12
R↓	27- 33	R/S	61- 31
R↓	28- 33	RCL 9	62- 45 9
R↓	29- 33	g 12÷	63- 43 12
RCL PV	30- 45 13	FV	64- 15
[+]	31- 40	f P/R	
CHS	32- 16		

132 Section 12: Real Estate and Lending

REGISTERS			
n: Period	i: Apprec.	PV: Price	PMT: Used
FV: Used	R ₀ : Period	R ₁ : Dwn Pmt	R ₂ : Life
R ₃ : i(Mtg)	R ₄ : Taxes/Mo	R ₅ : Improve.	R ₆ : Closing C.
R ₇ : % Comm.	R ₈ : Rent	R ₉ : Savings i	R ₀ : Bracket
R ₁ : Unused.			

1. Key in the program.
2. Key in the estimated down payment then press **[STO]1**.
3. Key in the life of the mortgage then press **[STO]2**.
4. Key in the annual mortgage interest rate then press **[STO]3**.
5. Key in the estimated monthly taxes then press **[STO]4**.
6. Key in the total amount estimated for monthly repairs, improvements, incremental insurance, utility costs, and other expenses, then press **[STO]5**.
7. Key in the closing costs then press **[STO]6**.
8. Key in the selling cost as a percentage of the selling price. This should include sales commission, escrow fees, etc. then press **[STO]7**.
9. Key in the monthly rent for the alternative housing then press **[STO]8**.
10. Key in the savings or alternative investment annual interest rate as a percentage then press **[STO]9**.
11. Key in the combined State and Federal marginal tax rate* as a percentage then press **[STO]0**.
12. Press **[f]CLEAR[FIN]** then key in the number of years involved in the investment; press **[n]**.
13. Key in the estimated rate of yearly appreciation as a percentage then press **[i]**.
14. Key in the price of the house under consideration then press **[PV]**.
15. Press **[R/S]** to compute the net proceeds from the sale of the house. (A negative value indicates money lost.)

* The user should key in the total marginal income tax — Federal plus State — to obtain calculations which reflect the tax advantages of home ownership. Because of the complexities of tax laws and different financial and tax considerations for each individual, this program should only serve as a guide in considering an investment of this type. For more specific, detailed information, consult a tax accountant or qualified tax advisor.

16. Press $\boxed{R/S}$ to compute the yield on your investment in the house.*
17. Press $\boxed{R/S}$ to compute the value of a savings account or other investment.
18. Compare the value of the hypothetical savings account to the net proceeds of the sale of the house. Examine the sign and magnitude of the yield to arrive at your decision.
19. To change data and repeat the calculations, store the changed values in the appropriate registers and go to step 12.

Example: You are being transferred for 4 years to a distant city and are faced with the decision of whether to rent or to buy a house. A quick survey of the housing market indicates that you can purchase an acceptable house for \$70,000 with a \$7,000 down payment on a 30 year mortgage at 12% interest. The closing costs would be about \$1200. Selling costs include a 6% commission for resale and miscellaneous other fees that amount to another 2% of the sale price. Housing in the area is appreciating 10% per year. Property taxes would be about \$110 per month, and you estimate that maintenance would cost an additional \$65 per month.

An alternative would be to rent a similar dwelling at \$400 per month and to invest the difference between the purchase cost and rent at $6\frac{1}{4}\%$ interest. Your personal income tax rate (marginal) is 25% Federal and 5% State. Which alternative is more financially attractive?

Keystrokes	Display	
\boxed{f} CLEAR \boxed{REG}	0.00	
7000 \boxed{STO} 1	7,000.00	Down payment.
30 \boxed{STO} 2	30.00	Life of mortgage.
12 \boxed{STO} 3	12.00	Interest rate.
110 \boxed{STO} 4	110.00	Property taxes.
65 \boxed{STO} 5	65.00	Monthly expenses.
1200 \boxed{STO} 6	1,200.00	Closing costs.
8 \boxed{STO} 7	8.00	Resale costs (as a percentage).
400 \boxed{STO} 8	400.00	Rent.
6.25 \boxed{STO} 9	6.25	Savings interest rate.
30 \boxed{STO} $\boxed{\cdot}$ 0	30.00	Tax bracket.
\boxed{f} CLEAR \boxed{FIN}	30.00	Clear financial registers.

* If the calculator displays a negative result or **Error 5** when solving for yield then your investment has resulted in a loss. The amount of interest earned on the alternative investment is not taken into account in this calculation.

134 Section 12: Real Estate and Lending

Keystrokes	Display	
4 <input type="text" value="n"/>	4 . 00	Years in investment.
10 <input type="text" value="i"/>	10 . 00	Yearly appreciation rate.
70000 <input type="text" value="PV"/>	70 , 000 . 00	House price.
<input type="text" value="R/S"/>	32 , 391 . 87	NCPR (calculated).
<input type="text" value="R/S"/>	19 . 56	Yield.
<input type="text" value="R/S"/>	21 , 533 . 79	Balance in savings.

By purchasing a house, you would gain \$10,858.08 (32,391.87 – 21,533.79) over an alternate investment at 6.25% interest.

Deferred Annuities

Sometimes transactions are established where payments do not begin for a specified number of periods; the payments are deferred. The technique for calculating *NPV* may be applied assuming zero for the first cash flow. Refer to pages 58 through 62.

Example 1: You have just inherited \$20,000 and wish to put some of it aside for your daughter's college education. You estimate that when she is of college age, 9 years from now, she will need \$7,000 at the beginning of each year for 4 years for college tuition and expenses. You wish to establish a fund which earns 6% annually. How much do you need to deposit in the fund today to meet your daughter's educational expenses?

Keystrokes	Display	
<input type="text" value="f"/> CLEAR <input type="text" value="REG"/>	0 . 00	Initialize.
0 <input type="text" value="g"/> <input type="text" value="CFo"/>	0 . 00	First cash flow.
0 <input type="text" value="g"/> <input type="text" value="CFj"/>	0 . 00	Second through ninth cash flows.
8 <input type="text" value="g"/> <input type="text" value="Nj"/>	8 . 00	
7000 <input type="text" value="g"/> <input type="text" value="CFi"/>	7 , 000 . 00	Tenth through thirteenth cash flows.
4 <input type="text" value="g"/> <input type="text" value="Ni"/>	4 . 00	
6 <input type="text" value="i"/>	6 . 00	Interest.
<input type="text" value="f"/> <input type="text" value="NPV"/>	15 , 218 . 35	NPV.

Leases often call for periodic contractual adjustments of rental payments. For example, a 2-year lease calls for monthly payments (at the beginning of the month) of \$500 per month for the first 6 months, \$600 per month for the next 12 months, and \$750 per month for the last 6 months. This situation illustrates what is called a “step-up” lease. A “step-down” lease is similar, except that rental payments are decreased periodically according to the lease contract. Lease payments are made at the beginning of the period.

In the example cited, the rental payment stream for months 7 through 24 are “deferred annuities,” as they start at some time in the future. The cash flow diagram from the investor’s viewpoint looks like this:

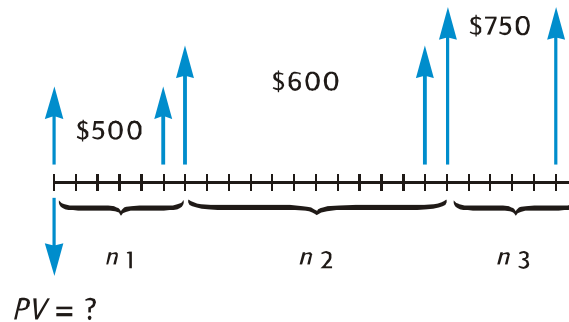

To find today’s present value of the cash flows assuming a desired yield, the NPV technique may be used. (Refer to pages 58 thru 62.)

Example 2: A 2-year lease calls for monthly payments (at the beginning of the month) of \$500 per month for the first 6 months, \$600 per month for the next 12 months, and \$750 per month for the last 6 months. If you wish to earn 13.5% annually on these cash flows, how much should you invest (what is the present value of the lease)?

Keystrokes	Display	
f CLEAR REG	0.00	Initialize.
500 g CF_0	500.00	First cash flow.
g CF_1	500.00	Second thru sixth cash flows.
5 g N_1	5.00	
600 g CF_1	600.00	Next twelve cash flows.
12 g N_1	12.00	
750 g CF_1	750.00	Last six cash flows.
6 g N_1	6.00	
13.5 g $\text{I}2\div$	1.13	Monthly interest rate.
f NPV	12,831.75	Amount to invest to achieve a 13.5% yield.

Section 13

Investment Analysis

Partial-Year Depreciation

For both income tax purposes and financial analyses, it is valuable to calculate depreciation based on a calendar or fiscal accounting year. When the acquisition date of an asset does not coincide with the start of the year — which is the rule rather than the exception — the amounts of depreciation in the first and last years are computed as fractions of a full year's depreciation.

Straight-Line Depreciation

The following hp 12c program calculates the straight-line depreciation for the year desired with the acquisition date occurring at any time during the year.

KEYSTROKES	DISPLAY	KEYSTROKES	DISPLAY
f P/R		—	21- 30
f CLEAR PRGM	00-	n	22- 11
1	01-	1 RCL 0	23- 45 0
2	02-	2 g x=0	24- 43 35
÷	03-	10 g GTO 35	25-43, 33 35
STO 1	04- 44	1 RCL 2	26- 45 2
x÷y	05-	34 g PSE	27- 43 31
STO 2	06- 44	2 RCL 0	28- 45 0
1	07-	1 f SL	29- 42 23
—	08-	30 R/S	30- 31
STO 0	09- 44	0 1	31- 1
1	10-	1 STO + 0	32-44 40 0
f SL	11- 42	23 STO + 2	33-44 40 2
RCL 1	12- 45	1 g GTO 26	34-43, 33 26
X	13-	20 RCL 2	35- 45 2

KEYSTROKES	DISPLAY	KEYSTROKES	DISPLAY
$\boxed{\text{STO}}\ 3$	14- 44 3	$\boxed{\text{g}}\ \boxed{\text{PSE}}$	36- 43 31
$\boxed{\text{RCL}}\ \boxed{\text{PV}}$	15- 45 13	$\boxed{\text{RCL}}\ \boxed{\text{PV}}$	37- 45 13
$\boxed{\text{x}\ \boxed{\text{y}}}$	16- 34	$\boxed{\text{RCL}}\ \boxed{\text{FV}}$	38- 45 15
$\boxed{-}$	17- 30	$\boxed{-}$	39- 30
$\boxed{\text{PV}}$	18- 13	$\boxed{\text{RCL}}\ 3$	40- 45 3
$\boxed{\text{RCL}}\ \boxed{\text{n}}$	19- 45 11	$\boxed{\text{g}}\ \boxed{\text{GTO}}\ 30$	41-43, 33 30
$\boxed{\text{RCL}}\ 1$	20- 45 1	$\boxed{\text{f}}\ \boxed{\text{P/R}}$	

REGISTERS			
n: Life	i: Unused	PV: Dep. Value	PMT: Unused
FV: Salvage	R_0 : Used	R_1 : #Mos./12	R_2 : Counter
R_3 : 1 st Yr. Dep.	R_4 - R_4 : Unused		

1. Key in the program.
2. Press $\boxed{\text{f}}\ \boxed{\text{CLEAR}}\ \boxed{\text{FIN}}$.
3. Key in the book value then press $\boxed{\text{PV}}$.
4. Key in the salvage value then press $\boxed{\text{FV}}$.
5. Key in the life in years (an integer) then press $\boxed{\text{n}}$.
6. Key in the year desired then press $\boxed{\text{ENTER}}$.
7. Key in the number of months in the first year and press $\boxed{\text{R/S}}$. * The display will show the amount of depreciation for the desired year. If desired, press $\boxed{\text{x}\ \boxed{\text{y}}}$ to see the remaining depreciable value then press $\boxed{\text{RCL}}\ \boxed{\text{PV}}\ \boxed{\text{RCL}}\ 3\ \boxed{+}\ \boxed{\text{x}\ \boxed{\text{y}}}\ \boxed{-}\ \boxed{\text{RCL}}\ \boxed{\text{FV}}\ \boxed{-}$ to find the total depreciation from the first year through the current year.
8. Press $\boxed{\text{R/S}}$ for the amount of depreciation and remaining depreciable value for the next year. Repeat this step for the following years.
9. For a new case, press $\boxed{\text{g}}\ \boxed{\text{GTO}}\ 00$ and return to step 2.

* The display will pause showing the year number before showing the amount of depreciation for that year.

138 Section 13: Investment Analysis

Note: If the number of months in the first calendar year is less than 12, the amount of depreciation in the 1st year will be less than a full year's depreciation. The actual number of years that depreciation will occur is equal to the life +1. For example, a drill has a life of 3 years and is purchased 3 months before the year end. The following time diagram shows that depreciation will occur over 4 calendar years.

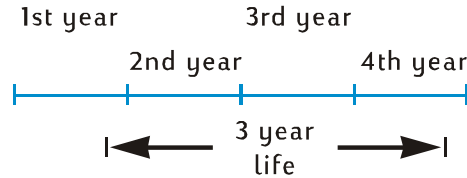

Example 1: A property has just been purchased for \$150,000. The purchase price is allocated between \$25,000 for land and \$125,000 for improvements (building). The remaining useful life of the building is agreed to be 25 years. There is no salvage value forecasted at the end of the useful life of the building. Thus, the depreciable value and book value is \$125,000.

The building was acquired 4 months before the end of the year. Using straight-line depreciation, find the amount of depreciation and remaining depreciable value for the 1st, 2nd, 25th, and 26th years. What is the total depreciation after 3 years?

Keystrokes

Display

<input type="button" value="f"/> CLEAR <input type="button" value="FIN"/>		Salvage value = 0 so $FV = 0$.
125000 <input type="button" value="PV"/>	125,000.00	Book value.
25 <input type="button" value="n"/>	25.00	Life.
1 <input type="button" value="ENTER"/>	1.00	Year desired.
4 <input type="button" value="R/S"/>	1.00	First year:
<input type="button" value="x>y"/>	1,666.67	depreciation,
<input type="button" value="R/S"/>	123,333.33	remaining depreciable value.
<input type="button" value="x>y"/>	2.00	Second year:
<input type="button" value="R/S"/>	5,000.00	depreciation,
<input type="button" value="x>y"/>	118,333.33	remaining depreciable value.
<input type="button" value="R/S"/>	3.00	Third year:
<input type="button" value="R/S"/>	5,000.00	depreciation.
<input type="button" value="x>y"/> <input type="button" value="RCL"/> <input type="button" value="PV"/> <input type="button" value="RCL"/> 3		
<input type="button" value="+"/> <input type="button" value="x>y"/> <input type="button" value="-"/>		
<input type="button" value="g"/> <input type="button" value="GTO"/> 00	11,666.67	Total depreciation through third year.
<input type="button" value="f"/> CLEAR <input type="button" value="FIN"/>	11,666.67	
125000 <input type="button" value="PV"/>	125,000.00	Book value.

Keystrokes	Display	
25 [n]	25.00	Life.
25 [ENTER]	25.00	Year desired.
4 [R/S]	25.00	Twenty-fifth year:
[x≧y]	5,000.00	depreciation,
[R/S]	3,333.33	remaining depreciable value.
[R/S]	26.00	Twenty-sixth year:
[x≧y]	3,333.33	depreciation,
[R/S]	0.00	remaining depreciable value.

Example 2: A new car was purchased for \$6,730 with 4¹/₂ months remaining in the year. If the expected life of the car is 5 years, what is the amount of depreciation in the first year?

Keystrokes	Display	
[g] [GTO] 00		
[f] [CLEAR] [FIN]		
6730 [PV]	6,730.00	Book value.
5 [n]	5.00	Life.
1 [ENTER]	1.00	
4.5 [R/S]	1.00	First year:
	504.75	depreciation.

Declining-Balance Depreciation

The following hp 12c program calculates the declining-balance depreciation for the year desired with the acquisition date occurring at any time during the year.

KEYSTROKES	DISPLAY	KEYSTROKES	DISPLAY
[f] [P/R]		[RCL] 0	19- 45 0
[f] [CLEAR] [PRGM]	00-	[g] [x=0]	20- 43 35
1	01- 1	[g] [GTO] 31	21-43, 33 31
2	02- 2	[RCL] 2	22- 45 2
[÷]	03- 10	[g] [PSE]	23- 43 31
[STO] 1	04- 44 1	[RCL] 0	24- 45 0
[x≧y]	05- 34	[f] [DB]	25- 42 25
[STO] 2	06- 44 2	[R/S]	26- 31

140 Section 13: Investment Analysis

KEYSTROKES	DISPLAY	KEYSTROKES	DISPLAY
1	07- 1	1	27- 1
\square	08- 30	\square \square 0	28-44 40 0
\square 0	09- 44 0	\square \square 2	29-44 40 2
1	10- 1	\square \square 22	30-43, 33 22
\square \square DB	11- 42 25	\square 2	31- 45 2
\square 1	12- 45 1	\square \square	32- 43 31
\square	13- 20	\square \square	33- 45 13
\square 3	14- 44 3	\square \square	34- 45 15
\square \square	15- 45 13	\square	35- 30
\square \square \square	16- 34	\square 3	36- 45 3
\square	17- 30	\square \square 26	37-43, 33 26
\square	18- 13	\square \square \square	

REGISTERS			
n: Life	i: Factor	PV: Dep. Value	PMT: Unused
FV: Salvage	R_0 : Used	R_1 : #Mos./12	R_2 : Counter
R_3 : 1 st Yr. Dep.	R_4 - R_4 : Unused		

1. Key in the program.
2. Press \square CLEAR \square FIN.
3. Key in the book value then press \square PV.
4. Key in the salvage value then press \square FV.
5. Key in the declining-balance factor as a percentage then press \square i.
6. Key in the life in years (an integer) then press \square n.
7. Key in the year desired then press \square ENTER.
8. Key in the number of months in first year* and press \square R/S.† The display will show the amount of depreciation for the desired year. Press \square \square \square to see the

* Refer to straight-line depreciation instruction note, page 137.

† The display will pause showing the year number before showing the amount of depreciation for that year.

remaining depreciable value. If desired, press

$\boxed{\text{RCL}}\boxed{\text{PV}}\boxed{\text{RCL}}\boxed{3}\boxed{+}\boxed{\text{X}\approx\text{Y}}\boxed{-}\boxed{\text{RCL}}\boxed{\text{FV}}\boxed{-}$ to find the total depreciation through the current year.

9. Press $\boxed{\text{R/S}}$ for the amount of depreciation then, if desired, press $\boxed{\text{X}\approx\text{Y}}$ for the remaining depreciable value for the next year. Repeat this step for the following years.

10. For a new case press $\boxed{\text{g}}\boxed{\text{GTO}}\boxed{00}$ and return to step 2.

Example: An electron beam welder which costs \$50,000 is purchased 4 months before the end of the accounting year. What will the depreciation be during the first full accounting year (year 2) if the welder has a 6 year depreciable life, a salvage value of \$8,000 and is depreciated using the declining-balance depreciation method? The declining-balance factor is 150%.

Keystrokes	Display	
$\boxed{\text{f}}\boxed{\text{CLEAR}}\boxed{\text{FIN}}$		
50000 $\boxed{\text{PV}}$	50,000.00	Book value.
8000 $\boxed{\text{FV}}$	8,000.00	Salvage value.
150 $\boxed{\text{i}}$	150.00	Declining-balance factor.
6 $\boxed{\text{n}}$	6.00	Life.
2 $\boxed{\text{ENTER}}$	2.00	Year desired.
4 $\boxed{\text{R/S}}$	2.00	Second year:
	11,458.33	depreciation.

Sum-of-the-Years-Digits Depreciation

The following hp 12c program calculates the sum-of-the-years-digits depreciation for the year desired with the acquisition date occurring at any time during the year.

KEYSTROKES	DISPLAY	KEYSTROKES	DISPLAY
$\boxed{\text{f}}\boxed{\text{P/R}}$		$\boxed{-}$	21- 30
$\boxed{\text{f}}\boxed{\text{CLEAR}}\boxed{\text{PRGM}}$	00-	$\boxed{\text{n}}$	22- 11
1	01-	1 $\boxed{\text{RCL}}\boxed{0}$	23- 45 0
2	02-	2 $\boxed{\text{g}}\boxed{\text{x=0}}$	24- 43 35
$\boxed{\div}$	03-	10 $\boxed{\text{g}}\boxed{\text{GTO}}\boxed{35}$	25-43, 33 35
$\boxed{\text{STO}}\boxed{1}$	04- 44	1 $\boxed{\text{RCL}}\boxed{2}$	26- 45 2
$\boxed{\text{X}\approx\text{Y}}$	05-	34 $\boxed{\text{g}}\boxed{\text{PSE}}$	27- 43 31

142 Section 13: Investment Analysis

KEYSTROKES	DISPLAY	KEYSTROKES	DISPLAY
$\boxed{\text{STO}}\boxed{2}$	06- 44 2	$\boxed{\text{RCL}}\boxed{0}$	28- 45 0
1	07- 1	$\boxed{f}\boxed{\text{SOYD}}$	29- 42 24
$\boxed{-}$	08- 30	$\boxed{\text{R/S}}$	30- 31
$\boxed{\text{STO}}\boxed{0}$	09- 44 0	1	31- 1
1	10- 1	$\boxed{\text{STO}}\boxed{+}\boxed{0}$	32-44 40 0
$\boxed{f}\boxed{\text{SOYD}}$	11- 42 24	$\boxed{\text{STO}}\boxed{+}\boxed{2}$	33-44 40 2
$\boxed{\text{RCL}}\boxed{1}$	12- 45 1	$\boxed{g}\boxed{\text{GTO}}\boxed{26}$	34-43, 33 26
$\boxed{\text{X}}$	13- 20	$\boxed{\text{RCL}}\boxed{2}$	35- 45 2
$\boxed{\text{STO}}\boxed{3}$	14- 44 3	$\boxed{g}\boxed{\text{PSE}}$	36- 43 31
$\boxed{\text{RCL}}\boxed{\text{PV}}$	15- 45 13	$\boxed{\text{RCL}}\boxed{\text{PV}}$	37- 45 13
$\boxed{\text{X}}\boxed{\approx}\boxed{y}$	16- 34	$\boxed{\text{RCL}}\boxed{\text{FV}}$	38- 45 15
$\boxed{-}$	17- 30	$\boxed{-}$	39- 30
$\boxed{\text{PV}}$	18- 13	$\boxed{\text{RCL}}\boxed{3}$	40- 45 3
$\boxed{\text{RCL}}\boxed{n}$	19- 45 11	$\boxed{g}\boxed{\text{GTO}}\boxed{30}$	41-43, 33 30
$\boxed{\text{RCL}}\boxed{1}$	20- 45 1	$\boxed{f}\boxed{\text{P/R}}$	

REGISTERS			
n: Life	i: Unused	PV: Dep. Value	PMT: Unused
FV: Salvage	R_0 : Used	R_1 : #Mos./12	R_2 : Counter
R_3 : 1 st Yr. Dep.	R_4 - R_{14} : Unused		

1. Key in the program.
2. Press $\boxed{f}\boxed{\text{CLEAR}}\boxed{\text{FIN}}$.
3. Key in the book value then press $\boxed{\text{PV}}$.
4. Key in the salvage value then press $\boxed{\text{FV}}$.
5. Key in the life in years (an integer) then press \boxed{n} .
6. Key in the year desired then press $\boxed{\text{ENTER}}$.

7. Key in the number of months in first year* then press $\boxed{R/S}$.† The display will show the amount of depreciation for the desired year. If desired, press $\boxed{X\approx Y}$ to see the remaining depreciable value, then press $\boxed{RCL} \boxed{PV} \boxed{RCL} \boxed{3} \boxed{+}$ $\boxed{X\approx Y} \boxed{-} \boxed{RCL} \boxed{FV} \boxed{-}$ to find the total depreciation through the current year.
8. Press $\boxed{R/S}$ for the amount of depreciation then, if desired, press $\boxed{X\approx Y}$ for the remaining depreciable value for the next year. Repeat this step for the following years.
9. For a new case press $\boxed{g} \boxed{GTO} \boxed{00}$ and return to step 2.

Example: A commercial movie camera is purchased for \$12,000. If maintained properly, the camera has a useful life expectancy of 25 years with \$500 salvage value. Using the sum-of-the-years-digits method, what is the amount of depreciation and the remaining depreciable value for the 4th and 5th years? Assume the first depreciation year is 11 months long.

Keystrokes	Display	
$\boxed{f} \boxed{CLEAR} \boxed{FIN}$		
12000 \boxed{PV}	12,000.00	Book value.
500 \boxed{FV}	500.00	Salvage value.
25 \boxed{n}	25.00	Life.
4 \boxed{ENTER}	4.00	Year desired.
11 $\boxed{R/S}$	4.00	Fourth year:
$\boxed{X\approx Y}$	781.41	depreciation,
$\boxed{R/S}$	8,238.71	remaining depreciable value.
$\boxed{X\approx Y}$	5.00	Fifth year:
$\boxed{R/S}$	746.02	depreciation,
$\boxed{X\approx Y}$	7,492.69	remaining depreciable value.

* Refer to straight-line depreciation instruction note, page 137.

† The display will pause showing the year number before showing the amount of depreciation for that year.

Full- and Partial-Year Depreciation with Crossover

When calculating declining-balance depreciation it is often advantageous for tax purposes to switch from declining balance to straight-line depreciation at some point. This hp 12c program calculates the optimum crossover point and automatically switches to straight-line depreciation at the appropriate time. The crossover point is the end of the year in which the declining-balance depreciation last exceeds or equals the amount of straight-line depreciation. The straight-line depreciation is determined by dividing the remaining depreciable value by the remaining useful life.

Given the desired year and the number of months in the first year, this program calculates the depreciation for the desired year, the remaining depreciable value, and the total depreciation through the current year.

KEYSTROKES	DISPLAY	KEYSTROKES	DISPLAY
$\boxed{f} \boxed{P/R}$		$\boxed{RCL} \boxed{4}$	48- 45 4
$\boxed{f} \boxed{CLEAR} \boxed{PRGM}$	00-	$\boxed{\div}$	49- 10
1	01- 1	$\boxed{g} \boxed{x\leq y}$	50- 43 34
2	02- 2	$\boxed{g} \boxed{GTO} \boxed{53}$	51-43, 33 53
$\boxed{\div}$	03- 10	$\boxed{g} \boxed{GTO} \boxed{65}$	52-43, 33 65
$\boxed{STO} \boxed{6}$	04- 44 6	$\boxed{R!}$	53- 33
$\boxed{RCL} \boxed{n}$	05- 45 11	0	54- 0
$\boxed{x\geq y}$	06- 34	$\boxed{RCL} \boxed{0}$	55- 45 0
$\boxed{-}$	07- 30	$\boxed{g} \boxed{x\leq y}$	56- 43 34
$\boxed{STO} \boxed{4}$	08- 44 4	$\boxed{g} \boxed{GTO} \boxed{86}$	57-43, 33 86
$\boxed{R!}$	09- 33	$\boxed{RCL} \boxed{PV}$	58- 45 13
$\boxed{STO} \boxed{0}$	10- 44 0	$\boxed{RCL} \boxed{5}$	59- 45 5
1	11- 1	$\boxed{-}$	60- 30
$\boxed{STO} \boxed{-} \boxed{0}$	12-44 30 0	\boxed{PV}	61- 13
$\boxed{STO} \boxed{2}$	13- 44 2	1	62- 1
$\boxed{STO} \boxed{3}$	14- 44 3	$\boxed{STO} \boxed{-} \boxed{4}$	63-44 30 4
$\boxed{f} \boxed{DB}$	15- 42 25	$\boxed{g} \boxed{GTO} \boxed{40}$	64-43, 33 40
$\boxed{RCL} \boxed{6}$	16- 45 6	$\boxed{RCL} \boxed{4}$	65- 45 4

KEYSTROKES	DISPLAY	KEYSTROKES	DISPLAY
\boxed{X}	17- 20	\boxed{n}	66- 11
$\boxed{STO} 1$	18- 44 1	0	67- 0
$\boxed{RCL} \boxed{PV}$	19- 45 13	$\boxed{STO} 6$	68- 44 6
$\boxed{X} \Rightarrow \boxed{Y}$	20- 34	1	69- 1
$\boxed{-}$	21- 30	$\boxed{STO} \boxed{-} 2$	70-44 30 2
\boxed{PV}	22- 13	$\boxed{STO} \boxed{+} 0$	71-44 40 0
\boxed{ENTER}	23- 36	$\boxed{RCL} 5$	72- 45 5
$\boxed{g} \boxed{LSTx}$	24- 43 36	$\boxed{STO} \boxed{-} 1$	73-44 30 1
$\boxed{X} \Rightarrow \boxed{Y}$	25- 34	$\boxed{RCL} 3$	74- 45 3
$\boxed{RCL} \boxed{FV}$	26- 45 15	$\boxed{f} \boxed{SL}$	75- 42 23
$\boxed{-}$	27- 30	$\boxed{STO} \boxed{+} 1$	76-44 40 1
$\boxed{X} \Rightarrow \boxed{Y}$	28- 34	1	77- 1
$\boxed{RCL} 0$	29- 45 0	$\boxed{STO} \boxed{-} 0$	78-44 30 0
1	30- 1	$\boxed{STO} \boxed{+} 2$	79-44 40 2
$\boxed{g} \boxed{x} \Leftarrow \boxed{y}$	31- 43 34	$\boxed{STO} \boxed{+} 3$	80-44 40 3
$\boxed{g} \boxed{GTO} 39$	32-43, 33 39	$\boxed{R\downarrow}$	81- 33
$\boxed{R\downarrow}$	33- 33	$\boxed{RCL} 0$	82- 45 0
$\boxed{R\downarrow}$	34- 33	1	83- 1
1	35- 1	$\boxed{g} \boxed{x} \Leftarrow \boxed{y}$	84- 43 34
$\boxed{g} \boxed{PSE}$	36- 43 31	$\boxed{g} \boxed{GTO} 74$	85-43, 33 74
$\boxed{R\downarrow}$	37- 33	$\boxed{R\downarrow}$	86- 33
$\boxed{R/S}$	38- 31	$\boxed{R\downarrow}$	87- 33
1	39- 1	$\boxed{RCL} 2$	88- 45 2
$\boxed{STO} \boxed{+} 2$	40-44 40 2	$\boxed{g} \boxed{PSE}$	89- 43 31
$\boxed{STO} \boxed{-} 0$	41-44 30 0	$\boxed{R\downarrow}$	90- 33
$\boxed{f} \boxed{DB}$	42- 42 25	$\boxed{R/S}$	91- 31

146 Section 13: Investment Analysis

KEYSTROKES	DISPLAY	KEYSTROKES	DISPLAY
STO $\boxed{+}$ 1	43-44 40 1	RCL $\boxed{6}$	92- 45 6
STO 5	44- 44 5	\boxed{g} $\boxed{x=0}$	93- 43 35
RCL \boxed{PV}	45- 45 13	\boxed{g} \boxed{GTO} 74	94-43, 33 74
RCL \boxed{FV}	46- 45 15	\boxed{g} \boxed{GTO} 58	95-43, 33 58
$\boxed{-}$	47- 30	\boxed{f} $\boxed{P/R}$	

REGISTERS			
n: Life	i: Factor	PV: Dep. Value	PMT: Unused
FV: Salvage	R ₀ : Used	R ₁ : Dep.	R ₂ : Counter
R ₃ : Used	R ₄ : Used	R ₅ : Used	R ₆ : Used

1. Key in the program.
2. Press \boxed{f} CLEAR \boxed{REG} .
3. Key in the book value then press \boxed{PV} .
4. Key in the salvage value then press \boxed{FV} .
5. Key in the life in years (an integer) then press \boxed{n} .
6. Key in the declining-balance factor as a percentage then press \boxed{i} .
7. Key in the desired year and press \boxed{ENTER} .
8. Key in the number of months in the first year* then press $\boxed{R/S}$ † to calculate the amount of depreciation for the desired year.
9. If desired, press $\boxed{X\div Y}$ to see the remaining depreciable value.
10. If desired, press \boxed{RCL} 1 to see the total depreciation through the current year.
11. Continue pressing $\boxed{R/S}$ * to find the amount of depreciation for the successive years. Steps 9 and 10 may be repeated for each year.
12. For a new case press \boxed{g} \boxed{GTO} 00 and return to step 2.

* Refer to straight-line depreciation note page 137.

† The display will pause with the year number before displaying the amount of depreciation for that year.

Example: An electronic instrument is purchased for \$11,000, with 6 months remaining in the current fiscal year. The instrument's useful life is 8 years and the salvage value is expected to be \$500. Using a 200% declining-balance factor, generate a depreciation schedule for the instrument's complete life. What is the remaining depreciable value after the first year? What is the total depreciation after the 7th year?

Keystrokes	Display	
\boxed{f} CLEAR \boxed{REG}	0.00	
11000 \boxed{PV}	11,000.00	Book value.
500 \boxed{FV}	500.00	Salvage value.
8 \boxed{n}	8.00	Life.
200 \boxed{i}	200.00	Declining-balance factor.
1 \boxed{ENTER}	1.00	First year depreciation desired.
6 $\boxed{R/S}$	1.00	First year:
$\boxed{\times \div}$	1,375.00	depreciation,
$\boxed{R/S}$	9,125.00	remaining depreciable value.
$\boxed{R/S}$	2.00	Second year:
$\boxed{R/S}$	2,406.25	depreciation.
$\boxed{R/S}$	3.00	Third year:
$\boxed{R/S}$	1,804.69	depreciation.
$\boxed{R/S}$	4.00	Fourth year:
$\boxed{R/S}$	1,353.51	depreciation.
$\boxed{R/S}$	5.00	Fifth year:
$\boxed{R/S}$	1,015.14	depreciation.
$\boxed{R/S}$	6.00	Sixth year:
$\boxed{R/S}$	761.35	depreciation.*
$\boxed{R/S}$	7.00	Seventh year:
$\boxed{R/S}$	713.62	depreciation.
\boxed{RCL} 1	9,429.56	Total depreciation through the seventh year.
$\boxed{R/S}$	8.00	Eighth year:
$\boxed{R/S}$	713.63	depreciation
$\boxed{R/S}$	9.00	Ninth year:
$\boxed{R/S}$	356.81	depreciation.

* By observation the crossover was year 6. Years 7, 8, and 9 use straight-line depreciation.

Excess Depreciation

When accelerated depreciation is used, the difference between total depreciation charged over a given period of time and the total amount that would have been charged under straight-line depreciation is called excess depreciation. To obtain excess depreciation:

1. Calculate the total depreciation then press **ENTER**.
2. Key in the depreciable amount (cost less salvage) then press **ENTER**. Key in the useful life of the asset in years then press **÷**. Key in the number of years in the income projection period then press **X** to get the total straight-line depreciation charge.
3. Press **=** to get the excess depreciation.

Example: What is the excess depreciation in the previous example over 7 calendar years? (Because of the partial first year, there are $6\frac{1}{2}$ years depreciation in the first 7 calendar years.)

Keystrokes	Display	
9429.56 ENTER	9,429.56	Total depreciation through seventh year.
10500 ENTER	10,500.00	Depreciable amount.
8 ÷	1,312.50	Yearly straight-line depreciation.
6.5 X	8,531.25	Total straight-line depreciation.
=	898.31	Excess depreciation

Modified Internal Rate of Return

The traditional Internal Rate of Return (*IRR*) technique has several drawbacks which hamper its usefulness in some investment applications. The technique implicitly assumes that all cash flows are either reinvested or discounted at the computed yield rate. This assumption is financially reasonable as long as the rate is within a realistic borrowing and lending range (for example, 10% to 20%). When the *IRR* becomes significantly greater or smaller, the assumption becomes less valid and the resulting value less sound as an investment measure.

IRR also is limited by the number of times the sign of the cash flow changes (positive to negative or vice versa). For every change of sign, the *IRR* solution has the potential for an additional answer. The cash flow sequence in the example that follows has three sign changes and hence up to three potential internal rates of return. This particular example has three positive real answers: 1.86, 14.35, and 29. Although mathematically sound, multiple answers probably are meaningless as an investment measure.

This Modified Internal Rate of Return procedure (*MIRR*) is one of several *IRR* alternatives which avoids the drawbacks of the traditional *IRR* technique. The procedure eliminates the sign change problem and the reinvestment (or discounting) assumption by utilizing user stipulated reinvestment and borrowing rates.

Negative cash flows are discounted at a safe rate that reflects the return on an investment in a liquid account. The figure generally used is a short-term security (T-Bill) or bank passbook rate.

Positive cash flows are reinvested at a reinvestment rate which reflects the return on an investment of comparable risk. An average return rate on recent market investments might be used.

The steps in the procedure are:

1. Calculate the future value of the positive cash flows (*NFV*) at the reinvestment rate.
2. Calculate the present value of the negative cash flows (*NPV*) at the safe rate.
3. Knowing *n*, *PV*, and *FV*, solve for *i*.

Example: An investor has the following unconventional investment opportunity. The cash flows are:

Group	# of Months	Cash Flow (\$)
0	1	-180,000
1	5	100,000
2	5	-100,000
3	9	0
4	1	200,000

Calculate the *MIRR* using a safe rate of 6% and a reinvestment (risk) rate of 10%.

Keystrokes	Display	
<code>f CLEAR REG</code>	0 . 00	
<code>0 [g] CF0</code>	0 . 00	First cash flow.
<code>100000 [g] CF1</code>		
<code>5 [g] N1</code>	5 . 00	Second through sixth cash flows.
<code>0 [g] CF1 5 [g] N1</code>	5 . 00	Next five cash flows.
<code>0 [g] CF1 9 [g] N1</code>	9 . 00	Next nine cash flows.
<code>200000 [g] CF1</code>	200 , 000 . 00	Last cash flow.

150 Section 13: Investment Analysis

Keystrokes

10 **g** **12** **÷** **f** **NPV**
CHS **PV**
20 **n** **FV**
180000 **CHS** **g** **CFo**
0 **g** **CFj** 5 **g** **Nj**
100000 **CHS** **CFj**
5 **g** **Nj**
6 **g** **12** **÷** **f** **NPV**
20 **n** **i**
12 **X**

Display

657,152.37 NPV of positive cash flows.
775,797.83 NFV of positive cash flows.
-660,454.55 NPV of negative cash flows.
0.81 Monthly *MIRR*
9.70 Annual *MIRR*.

Section 14

Leasing

Advance Payments

Situations may exist where payments are made in advance (leasing is a good example). These agreements call for extra payments to be made when the transaction is closed.

This first procedure finds the periodic payment amount necessary to achieve a desired yield when a number of payments are made in advance. And, given the periodic payment, the second procedure calculates the periodic yield.

Solving For Payment

To calculate the payment, information is entered as follows:

1. Press \boxed{g} \boxed{END} and \boxed{f} \boxed{CLEAR} \boxed{FIN} .
2. Key in the total number of payments in the lease then press \boxed{ENTER} .
3. Key in the total number of payments made in advance then press \boxed{STO} $\boxed{0}$ $\boxed{-}$ \boxed{n} .
4. Key in or calculate the periodic interest rate as a percentage then press \boxed{i} .
5. Press $\boxed{1}$ \boxed{CHS} \boxed{PV} \boxed{RCL} $\boxed{0}$ $\boxed{+}$.
6. Key in the initial loan amount then press \boxed{x} $\boxed{\div}$ \boxed{y} $\boxed{\div}$, to obtain the periodic payment to be received by the lessor.

Example 1: Equipment worth \$750 is leased for 12 months. The equipment is assumed to have no salvage value at the end of the lease. The lessee has agreed to make three payments at the time of closing. What monthly payment is necessary to yield the lessor 10% annually?

Keystrokes	Display	
\boxed{g} \boxed{END}		
\boxed{f} \boxed{CLEAR} \boxed{FIN}		
12 \boxed{ENTER}	12.00	Duration of lease.
3 \boxed{STO} $\boxed{0}$ $\boxed{-}$ \boxed{n}	9.00	Number of periodic payments.
10 \boxed{g} $\boxed{12}$ $\boxed{\div}$	0.83	
1 \boxed{CHS} \boxed{PMT}	-1.00	
\boxed{PV} \boxed{RCL} $\boxed{0}$ $\boxed{+}$	11.64	
750 \boxed{x} $\boxed{\div}$ \boxed{y} $\boxed{\div}$	64.45	Monthly payment to be received.

152 Section 14: Leasing

If solving for the payment amount will be done repetitively, key in the following hp 12c program.

KEYSTROKES	DISPLAY	KEYSTROKES	DISPLAY
\boxed{f} $\boxed{P/R}$		1	09- 1
\boxed{f} \boxed{CLEAR} \boxed{PRGM}	00-	\boxed{CHS}	10- 16
\boxed{g} \boxed{END}	01- 43 8	\boxed{PMT}	11- 14
\boxed{f} \boxed{CLEAR} \boxed{FIN}	02- 42 34	\boxed{PV}	12- 13
\boxed{RCL} 0	03- 45 0	\boxed{RCL} 1	13- 45 1
\boxed{RCL} 1	04- 45 1	$\boxed{+}$	14- 40
$\boxed{-}$	05- 30	\boxed{RCL} 3	15- 45 3
\boxed{n}	06- 11	$\boxed{\times\div}$	16- 34
\boxed{RCL} 2	07- 45 2	$\boxed{\div}$	17- 10
\boxed{i}	08- 12	\boxed{f} $\boxed{P/R}$	

REGISTERS			
n: n-#Adv. Pmt.	i: i	PV: Used	PMT: -1
FV: 0	R_0 : n	R_1 : #Adv. Pmt.	R_2 : i
R_3 : Loan	R_4 - R_7 : Unused		

1. Key in the program.
2. Key in the total number of payments in the lease then press \boxed{STO} 0.
3. Key in the total number of payments made in advance then press \boxed{STO} 1.
4. Key in the periodic interest rate as a percentage then press \boxed{STO} 2.
5. Key in the loan amount and press \boxed{STO} 3; then press $\boxed{R/S}$ to obtain the periodic payment to be received by the lessor.
6. For a new case, return to step 2. The values changed from the previous case are the only values which need to be entered.

Example 2: Using the preceding program, solve for the monthly payment using the information given in example 1. Then change the yearly interest to 15% and solve for the new payment amount.

Keystrokes	Display	
12 STO 0	12 . 00	Duration of lease.
3 STO 1	3 . 00	Number of advance payments.
10 ENTER 12 ÷		
STO 2	0 . 83	Periodic interest rate.
750 STO 3 R/S	64 . 45	Monthly payment to be received.
15 ENTER 12 ÷		
STO 2 R/S	65 . 43	Monthly payment to achieve a 15% yield.

Example 3: Using the information from example 1, what monthly payment is necessary to yield the lessor 15% annually if one payment is due at the time of closing?

Assuming that the previous example was just solved, the keystrokes are as follows:

Keystrokes	Display	
1 STO 1 R/S	66 . 86	Monthly payment to be received.

Since this problem is an annuity due situation (one payment at the beginning of the period) the calculation could also be done as follows:

Keystrokes	Display	
g BEG		
f CLEAR FIN		
12 n 15 g 12 ÷	1 . 25	Periodic interest rate (into i).
750 CHS PV PMT	66 . 86	Monthly payment to be received.

154 Section 14: Leasing

Solving for Yield

To calculate the periodic yield, information is entered as follows:

1. Press \boxed{g} \boxed{END} and \boxed{f} \boxed{CLEAR} \boxed{FIN} .
2. Key in the total number of payments in the lease then press \boxed{ENTER} .
3. Key in the total number of payments made in advance then press \boxed{STO} $\boxed{0}$ $\boxed{-}$ \boxed{n} .
4. Key in the periodic payment to be received then press \boxed{PMT} .
5. Key in the total amount of the loan then press \boxed{CHS} \boxed{RCL} $\boxed{0}$ \boxed{RCL} \boxed{PMT} \boxed{X} $\boxed{+}$ \boxed{PV} .
6. Press \boxed{i} to obtain the periodic yield.

Example 1: A lease has been written to run for 60 months. The leased equipment has a value of \$25,000 with a \$600 monthly payment. The lessee has agreed to make 3 payments at the time of closing (\$1800). What is the annual yield to the lessor?

Keystrokes	Display	
\boxed{g} \boxed{END}		
\boxed{f} \boxed{CLEAR} \boxed{FIN}		
60 \boxed{ENTER} 3		
\boxed{STO} $\boxed{0}$ $\boxed{-}$ \boxed{n}	57.00	Number of periodic payments.
600 \boxed{PMT}		
25000 \boxed{CHS} \boxed{RCL} $\boxed{0}$	3.00	Number of advance payments.
\boxed{RCL} \boxed{PMT} \boxed{X} $\boxed{+}$ \boxed{PV}	-23,200.00	PV.
\boxed{i}	1.44	Monthly yield (calculated).
12 \boxed{X}	17.33	Annual yield (as a percentage).

If solving for yield will be done repetitively, key in the following hp 12c program:

KEYSTROKES	DISPLAY	KEYSTROKES	DISPLAY
\boxed{f} $\boxed{P/R}$		\boxed{RCL} 3	09- 45 3
\boxed{f} \boxed{CLEAR} \boxed{PRGM}	00-	\boxed{CHS}	10- 16
\boxed{g} \boxed{END}	01- 43 8	\boxed{RCL} 1	11- 45 1
\boxed{f} \boxed{CLEAR} \boxed{FIN}	02- 42 34	\boxed{RCL} \boxed{PMT}	12- 45 14
\boxed{RCL} 0	03- 45 0	\boxed{X}	13- 20
\boxed{RCL} 1	04- 45 1	$\boxed{+}$	14- 40
$\boxed{-}$	05- 30	\boxed{PV}	15- 13
\boxed{n}	06- 11	\boxed{i}	16- 12
\boxed{RCL} 2	07- 45 2	\boxed{RCL} \boxed{g} $\boxed{12\div}$	17-45, 43 12
\boxed{PMT}	08- 14	\boxed{f} $\boxed{P/R}$	

REGISTERS			
n: n-#Adv. Pmts.	i: i	PV: Used	PMT: Pmt.
FV: 0	R_0 : n	R_1 : Adv. Pmts.	R_2 : Pmt.
R_3 : Loan	R_4 - R_7 : Unused		

1. Key in the program.
2. Key in the total number of payments in the lease then press \boxed{STO} 0.
3. Key in the total number of payments made in advance then press \boxed{STO} 1.
4. Key in the periodic payment to be received then press \boxed{STO} 2.
5. Key in the total amount of the loan, then press \boxed{STO} 3; then press $\boxed{R/S}$ to obtain the periodic yield.
6. For a new case, return to step 2. The values changed from the previous case are the only values which need to be re-entered.

Example 2: Using the program, solve for yield using the same information given in example 1. Then change the payment to \$625 and solve for the yield.

Keystrokes	Display	
60 \boxed{STO} 0	60 . 00	Number of payments.
3 \boxed{STO} 1	3 . 00	Number of advance payments.
600 \boxed{STO} 2	600 . 00	Periodic payment.

156 Section 14: Leasing

Keystrokes

25000[STO]3[R/S]

625[STO]2[R/S]

Display

17.33

19.48

Annual yield (as a percentage).

Annual yield (as a percentage)
when *PMT* is increased \$25.

Advance Payments With Residual

Situations may arise where a transaction has advance payments and a residual value (salvage value) at the end of the normal term.

Solving for Payment

The following program solves for the periodic payment amount necessary to achieve a desired yield.

KEYSTROKES	DISPLAY	KEYSTROKES	DISPLAY
[f][P/R]		[FV]	14- 15
[f][CLEAR][PRGM]	00-	[RCL][n]	15- 45 11
[g][END]	01- 43 8	[RCL]4	16- 45 4
[f][CLEAR][FIN]	02- 42 34	[-]	17- 30
[RCL]0	03- 45 0	[n]	18- 11
[n]	04- 11	1	19- 1
[RCL]1	05- 45 1	[CHS]	20- 16
[i]	06- 12	[PMT]	21- 14
[RCL]3	07- 45 3	[PV]	22- 13
[FV]	08- 15	[RCL]4	23- 45 4
[PV]	09- 13	[+]	24- 40
[RCL]2	10- 45 2	[RCL]5	25- 45 5
[+]	11- 40	[x↔y]	26- 34
[STO]5	12- 44 5	[÷]	27- 10
0	13- 0	[f][P/R]	

REGISTERS			
n: Used.	i: Interest	PV: Used	PMT: -1.
FV: Residual	R ₀ : # Pmts (n)	R ₁ : Interest.	R ₂ : Loan.
R ₃ : Residual	R ₄ : # Adv. Pmt.	R ₅ : Used	R ₆ -R ₈ : Unused

1. Key in the program.
2. Key in the total number of payments then press $\boxed{\text{STO}}\boxed{0}$.
3. Key in or calculate the periodic interest rate then press $\boxed{\text{STO}}\boxed{1}$.
4. Key in the loan amount then press $\boxed{\text{STO}}\boxed{2}$.
5. Key in the residual value then press $\boxed{\text{STO}}\boxed{3}$.
6. Key in the total number of payments made in advance then press $\boxed{\text{STO}}\boxed{4}$. Then press $\boxed{\text{R/S}}$ to obtain the payment amount received by the lessor.
7. For a new case, return to step 2. The values changed from the previous case are the only values which need to be re-entered.

Example 1: A copier worth \$22,000 is to be leased for 48 months. The lessee has agreed to make 4 payments in advance, with a purchase option at the end of 48 months enabling him to buy the copier for 30% of the purchase price. What monthly payment is necessary to yield the lessor 15% annually:

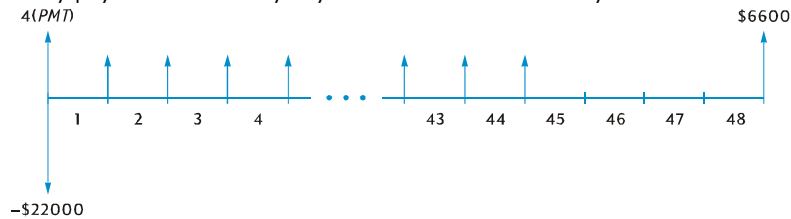

Keystrokes

Display

48 $\boxed{\text{STO}}\boxed{0}$

15 $\boxed{\text{ENTER}}$

12 $\boxed{\div}$ $\boxed{\text{STO}}\boxed{1}$

1 . 25 Monthly interest rate.

22000 $\boxed{\text{STO}}\boxed{2}$

30 $\boxed{\%}$ $\boxed{\text{STO}}\boxed{3}$

4 $\boxed{\text{STO}}\boxed{4}$ $\boxed{\text{R/S}}$

487 . 29 Monthly payment received by lessor.

158 Section 14: Leasing

Example 2: Using the information from example 1, what would the monthly payments be if the lessor desired a yield of 18% annually?

Keystrokes	Display	
	487.29	From previous example.
18 [ENTER] 12 $\text{[}\div\text{]}$	1.50	Monthly interest rate.
[STO] 1 [R/S]	520.81	Monthly payment received by lessor.

Solving For Yield

Solving for yield is essentially the same as solving for Internal Rate of Return (*IRR*). The keystrokes are as follows:

1. Press [f] CLEAR [REG] .
2. Key in the amount of the first cash flow then press [g] [CF0] . This initial amount is the difference between the initial loan amount and any payments received at closing time. Observe the sign convention: positive for cash received and negative for cash paid out.
3. Key in the amount of the first cash flow then press [g] [CF1] . Then key in the number of times that cash flow occurs then press [g] [N1] .
4. Key in 0 [g] [CFi] then the number of advance payments minus one. Then press [g] [Ni] .
5. Key in the residual then press [g] [CFi] . Then press [f] [IRR] to solve for periodic yield.

Example: Equipment worth \$5000 is leased for 36 months at \$145 per month. The lessee has agreed to pay the first and last month's payments in advance. At the end of the lease, the equipment may be purchased for \$1500. What is the annual yield to the lessor if the equipment is purchased?

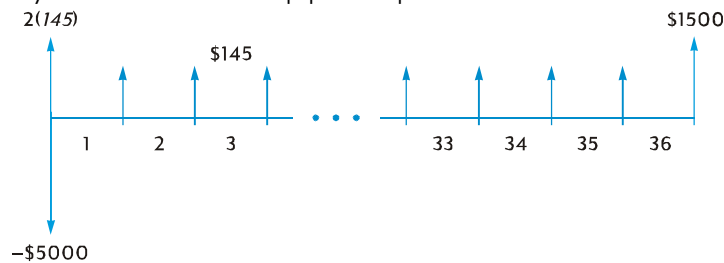

Keystrokes	Display
[f] CLEAR [REG]	
5000 [CHS] [ENTER]	
145 [ENTER] 2	

Keystrokes

$\boxed{\times} \boxed{+} \boxed{g} \boxed{CF_0}$
 $145 \boxed{g} \boxed{CF_i} 34 \boxed{g} \boxed{N_i}$
 $0 \boxed{g} \boxed{CF_i}$
 $1500 \boxed{g} \boxed{CF_i}$
 $\boxed{f} \boxed{IRR} 12 \boxed{\times}$

Display

$-4,710.00$ Net amount of cash advanced.
 34.00 Thirty-four cash flows of \$145.00.
 0.00 Thirty-fifth cash flow.
 $1,500.00$ Thirty-sixth cash flow.
 18.10 Annual yield to lessor.

Section 15

Savings

Nominal Rate Converted to Effective Rate

Given a nominal interest rate and the number of compounding periods per year, this keystroke procedure computes the effective annual interest rate.

1. Press \boxed{g} \boxed{END} and \boxed{f} \boxed{CLEAR} \boxed{FIN} .
2. Key in the annual nominal rate as a percentage, then press \boxed{ENTER} .
3. Key in the number of compounding periods per year, then press \boxed{n} $\boxed{\div}$ \boxed{i} .
4. Key in 100 then press \boxed{CHS} \boxed{ENTER} \boxed{PV} .
5. Press \boxed{FV} $\boxed{+}$ to obtain the effective annual interest rate.

Example 1: What is the effective annual interest rate if the annual nominal rate of $5\frac{1}{4}\%$ is compounded quarterly?

Keystrokes	Display	
\boxed{g} \boxed{END}		
\boxed{f} \boxed{CLEAR} \boxed{FIN}		
5.25 \boxed{ENTER}	5.25	Nominal rate.
4 \boxed{n} $\boxed{\div}$ \boxed{i}	1.31	Percent quarterly interest rate.
100 \boxed{CHS} \boxed{ENTER}		
\boxed{PV} \boxed{FV} $\boxed{+}$	5.35	Percent effective interest rate.

For repeated calculations, the following hp 12c program can be used:

KEYSTROKES	DISPLAY	KEYSTROKES	DISPLAY
\boxed{f} $\boxed{P/R}$		0	07- 0
\boxed{f} \boxed{CLEAR} \boxed{PRGM}	00-	0	08- 0
\boxed{g} \boxed{END}	01- 43 8	\boxed{CHS}	09- 16
\boxed{f} \boxed{CLEAR} \boxed{FIN}	02- 42 34	\boxed{ENTER}	10- 36
\boxed{n}	03- 11	\boxed{PV}	11- 13
$\boxed{\div}$	04- 10	\boxed{FV}	12- 15
\boxed{i}	05- 12	$\boxed{+}$	13- 40
1	06- 1	\boxed{f} $\boxed{P/R}$	

REGISTERS			
n: # Periods.	i: Nom. Rate/n	PV: 0	PMT: Used.
FV: Eff. Rate	R_0 - R_g : Unused		

1. Key in the program.
2. Key in the annual nominal rate as a percentage then press **ENTER**.
3. Key in the number of compounding periods per year then press **R/S** to obtain the effective annual interest rate.
4. For a new case return to step 2.

Example 2: What is the effective annual rate of interest if the annual nominal rate of $5\frac{1}{4}\%$ is compounded monthly?

Keystrokes	Display
5.25 ENTER	
12 R/S	5.38 Percent effective interest rate.

Effective Rate Converted to Nominal Rate

Given an effective interest rate and the number of compounding periods per year, this routine calculates the nominal interest rate.

1. Press **f****CLEAR****FIN**.
2. Key in the number of periods per year then press **n**.
3. Key in 100 then press **ENTER****PV**.
4. Key in the effective annual rate as a percentage then press **+****CHS****FV****i**.
5. Press **RCL****n****X** to obtain the annual nominal rate.

Example: Find the nominal rate if the effective annual rate is 5.35% compounded quarterly.

Keystrokes	Display
f CLEAR FIN	
4 n 100 ENTER PV	100.00
5.35 + CHS	-105.35
FV i	1.31
RCL n X	5.25 Percent nominal interest rate.

162 Section 15: Savings

Nominal Rate Converted to Continuous Effective Rate

This procedure converts a nominal annual interest rate to the continuous effective rate.

1. Press 1 \square ENTER \square .
2. Key in the nominal rate as a percentage then press \square % \square .
3. Press \square g \square e^x \square Δ% \square .

Example: What is the effective rate resulting from a $5\frac{1}{4}\%$ passbook rate with continuous compounding?

Keystrokes	Display	
1 \square ENTER \square 5.25 \square % \square		
\square g \square e ^x \square	1.05	
\square Δ% \square	5.39	Continuous rate.

Section 16

Bonds

30/360 Day Basis Bonds

A bond is a contract to pay interest, usually semiannually, at a given rate (coupon) and to pay the principal of the bond at some specified future date. A bond which is calculated on a 30/360 day basis is one in which the day count basis is computed using 30 days in a month and 360 days in a year.

The following program solves for the price given the yield or for the yield given the price of a semiannual coupon bond which is calculated on a 30/360 day basis and is held for more than six months.

KEYSTROKES	DISPLAY	KEYSTROKES	DISPLAY
f P/R		RCL 6	24- 45 6
f CLEAR PRGM	00-	X	25- 20
f CLEAR FIN	01- 42 34	RCL 0	26- 45 0
g BEG	02- 43 7	g x=0	27- 43 35
RCL 2	03- 45 2	g GTO 39	28-43, 33 39
2	04- 2	2	29- 2
÷	05- 10	÷	30- 10
PMT	06- 14	i	31- 12
STO 6	07- 44 6	PV	32- 13
RCL 5	08- 45 5	CHS	33- 16
+	09- 40	x↔y	34- 34
FV	10- 15	-	35- 30
RCL 3	11- 45 3	g LSTx	36- 43 36
RCL 4	12- 45 4	x↔y	37- 34
g ADYS	13- 43 26	g GTO 00	38-43, 33 00

164 Section 16: Bonds

KEYSTROKES	DISPLAY	KEYSTROKES	DISPLAY
$\boxed{R\downarrow}$	14- 33	$\boxed{R\downarrow}$	39- 33
1	15- 1	$\boxed{RCL} 1$	40- 45 1
8	16- 8	$\boxed{+}$	41- 40
0	17- 0	\boxed{CHS}	42- 16
$\boxed{\div}$	18- 10	\boxed{PV}	43- 13
\boxed{n}	19- 11	\boxed{i}	44- 12
$\boxed{g} \boxed{FRAC}$	20- 43 24	2	45- 2
1	21- 1	\boxed{X}	46- 20
$\boxed{X\approx y}$	22- 34	$\boxed{f} \boxed{P/R}$	
$\boxed{-}$	23- 30		

REGISTERS			
n: Δ days/180	i: Yield/2	PV: Price	PMT: Coupon/2.
FV: Red+Cpn./2	R_0 : Yield	R_1 : Price.	R_2 : Coupon
R_3 : D_{set}	R_4 : D_{mat}	R_5 : Redemption	R_6 : Coupon/2.
R_7 - R_9 : Unused			

1. Key in the program.
2. If the **C** status indicator is not displayed, press $\boxed{STO} \boxed{EEX}$.
3. Key in the annual coupon interest rate as a percentage then press $\boxed{STO} \boxed{2}$.
4. Key in the settlement date (MM.DDYYYY)* then press $\boxed{STO} \boxed{3}$.
5. Key in the maturity date (MM.DDYYYY)* then press $\boxed{STO} \boxed{4}$.
6. Key in the redemption value as a percentage of par then press $\boxed{STO} \boxed{5}$.
7. If price is desired:
 - a. Key in the desired yield to maturity as a percentage then press $\boxed{STO} \boxed{0}$.
 - b. Press $\boxed{R/S}$ to calculate price as a percentage of par value.
 - c. Press $\boxed{X\approx y}$ to display accrued interest due the seller.

* For information about date format see pages 29 to 30.

For a new case return to step 3. Note that only those values which have been changed need to be reentered and stored.

8. If yield is desired:
 - a. Press 0 **STO** 0.
 - b. Key in the price as a percentage of par value and press **STO** 1.
 - c. Press **R/S** to compute annual yield to maturity.

For a new case return to step 3. Note that only those values which have been changed need to be reentered and stored.

Example 1: What price should you pay on August 28, 2004 for a 5¹/₂% bond (computed with a 30/360 basis) that matures on June 1, 2008, if you want a yield of 7³/₄%? What price should you pay for a yield of 8%? This problem assumes a redemption value of 100.

Keystrokes	Display	
STO EE X		Set compound interest mode if the C indicator is not on.
5.5 STO 2	5.50	Coupon into register 2.
8.282004 STO 3	8.28	Settlement date into register 3.
6.012008 STO 4	6.01	Maturity date into register 4.
100 STO 5	100.00	Redemption value into register 5.
7.75 STO 0	7.75	Yield into register 0.
R/S	92.77	Price (calculated).
x ⇨ y	1.33	Accrued interest (calculated).
8 STO 0	8.00	New yield into register 0.
R/S	92.01	Price to yield 8% (calculated).
x ⇨ y	1.33	Accrued interest (calculated).
+	93.34	Total price paid.

Example 2: The market is quoting 93³/₈% for the bond described in example 1. What yield will that provide? What would be the yield to maturity if 92% were the quoted price?

Keystrokes	Display	
	93.34	From previous example.
0 STO 0		
3 ENTER 8 ÷		
93 + STO 1 R/S	7.55	Yield at 93 ³ / ₈ % (calculated).
92 STO 1 R/S	8.00	Yield at 92% (calculated).

166 Section 16: Bonds

Annual Coupon Bonds

For bonds which have annual coupons, use the following hp 12c program to evaluate price and accrued interest on an Actual/Actual day basis. This program may be modified for annual coupon bonds to be calculated on a 30/360 day basis.

KEYSTROKES	DISPLAY	KEYSTROKES	DISPLAY
f P/R		g ΔDYS	19- 43 26
f CLEAR PRGM	00-	STO 7	20- 44 7
f CLEAR FIN	01- 42 34	RCL 6	21- 45 6
g END	02- 43 8	RCL 4	22- 45 4
RCL 0	03- 45 0	g ΔDYS	23- 43 26
n	04- 11	RCL 7	24- 45 7
RCL 2	05- 45 2	÷	25- 10
PMT	06- 14	n	26- 11
RCL 1	07- 45 1	0	27- 0
i	08- 12	PMT	28- 14
RCL 3	09- 45 3	FV	29- 15
FV	10- 15	CHS	30- 16
PV	11- 13	RCL n	31- 45 11
RCL 5	12- 45 5	RCL 2	32- 45 2
EEX	13- 26	CHS	33- 16
6	14- 6	X	34- 20
CHS	15- 16	R/S	35- 31
-	16- 30	-	36- 30
STO 6	17- 44 6	f P/R	
RCL 5	18- 45 5		

REGISTERS			
n: Used	i: Yield	PV: Used	PMT: Cpn. or 0
FV: Used	R ₀ : # Periods (n)	R ₁ : Yield	R ₂ : Coupon
R ₃ : Redemption	R ₄ : Settlement	R ₅ : Next Cpn.	R ₆ : Last Coupon
R ₇ : Used	R ₈ -R ₅ : Unused		

For annual coupon bonds calculated on a 30/360 day basis, insert **[R]** after **[g]** **[ADYS]** at steps 19 and 23 (making the program two steps longer).

1. Key in the program and press **[STO][EEX]** if the **C** status indicator is not displayed.
2. Key in the total number of coupons which are received and press **[STO]0**.
3. Key in the annual yield as a percentage then press **[STO]1**.
4. Key in the amount of the annual coupon then press **[STO]2**.*
5. Key in the redemption value then press **[STO]3**.*
6. Key in the settlement (purchase) date† then press **[STO]4**.
7. Key in the date of the next coupon then press **[STO]5**.
8. Press **[R/S]** to obtain the amount of accrued interest.
9. Press **[R/S]** to determine the price of the bond.
10. For a new case, return to step 2.

Example: What is the price and accrued interest of a 20-year Eurobond with annual coupons of 6.5% purchased on August 15, 2004 to yield 7%. The next coupon is received on December 1, 2004.

Keystrokes	Display	
[STO][EEX]		Set compound interest mode if the C indicator is not on.
20 [STO]0	20.00	Total number of coupons.
7 [STO]1	7.00	Annual yield.
6.5 [STO]2	6.50	Annual coupon rate.
100 [STO]3	100.00	Redemption value.
8.152004 [STO]4	8.15	Settlement date.
12.012004 [STO]5	12.01	Next coupon date.
[R/S]	-4.58	Accrued interest.
[R/S]	-94.75	Purchase price.

* Positive for cash received; negative for cash paid out.

† For information about date format see pages 29 to 30.

Appendixes

Appendix A

The Automatic Memory Stack

Four special registers in the hp 12c are used for storing numbers during calculations. To understand how these registers are used, they should be visualized as stacked on top of each other.

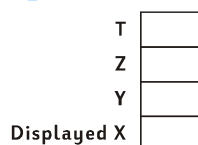

(For this reason, they are generally referred to as the “stack registers” or collectively as “the stack.”) The stack registers are designated X, Y, Z, and T. Unless the calculator is in Program mode, the number shown in the display is the number in the X-register (modified according to the current display format).

The number in the X-register — and, for two-number functions, the number in the Y-register — are the number(s) used in calculations. The Z- and T-registers are used primarily for the automatic retention of intermediate results during chain calculations, as described in section 1.

Before we discuss the details of the stack operation, let’s take a quick look at how the stack is used in a simple arithmetic calculation and in a chain calculation. For each key pressed in the keystroke sequence, the diagram illustrating the calculation shows, above the key, the numbers in each of the stack registers after that key is pressed.

First, let’s consider the calculation of $5 - 2$:

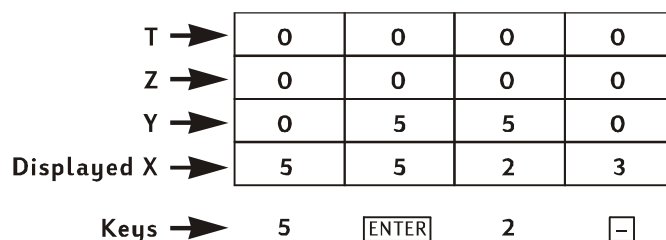

The diagram shows why we said in section 1 that the **ENTER** key *separates* the second number entered from the first number entered. Note also that this positions the 5 in the Y-register above the 2 in the X-register — just like they would be positioned if you wrote the calculation vertically on paper:

$$\begin{array}{r} 5 \\ -2 \\ \hline \end{array}$$

Now let's see what happens in the stack during a chain calculation:

$$\frac{(3 \times 4) + (5 \times 6)}{7}$$

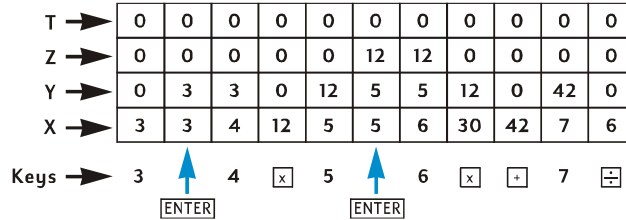

See how the intermediate results are not only displayed when they are calculated, but also automatically stored and available in the stack at just the right time!

That's basically how the stack operates. In the rest of this appendix, we'll take a more detailed look at how numbers are entered into and rearranged within the stack, and the effect of the various hp 12c functions on the numbers in the stack.

Getting Numbers Into the Stack: The ENTER Key

As discussed in earlier sections, if two numbers are being keyed in for a two-number function — such as + — you press ENTER between the numbers to separate them. The following diagram illustrates what happens in the stack when you enter the numbers 10 and 3 (to calculate, for example, $10 \div 3$). (Assume that the stack registers have been already loaded with the numbers shown as the result of previous calculations).

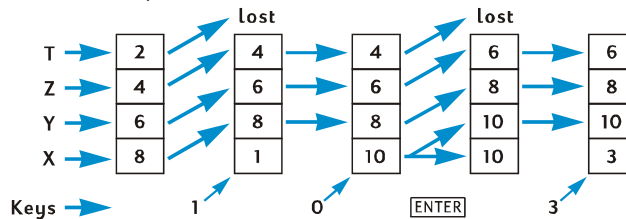

When a digit is keyed into the display, it is simultaneously entered into the X-register. As additional digit keys are pressed, the corresponding digits are appended (that is, added to the right of) those already in the displayed X-register until ENTER is pressed. As shown in the preceding diagram, pressing ENTER does the following:

1. It copies the number from the displayed X-register into the Y-register. This process is part of the *stack lift*.
2. It tells the calculator that the number in the displayed X-register is complete: that is, it *terminates digit entry*.

172 Appendix A: The Automatic Memory Stack

Termination of Digit Entry

The first digit keyed in after digit entry has been terminated *replaces* the number already in the displayed X-register. Digit entry is automatically terminated when any key is pressed (except for digit entry keys — digit keys, \square , \square , \square , and \square — and prefix keys — \square , \square , \square , \square , and \square).

Stack Lift

When the stack lifts, the number in each stack register is copied into the register above, and the number formerly in the T-register is lost. The number formerly in the X-register is then contained in both the X-register and the Y-register.

When a number is entered into the displayed X-register — either from the keyboard, from a storage register (using \square), or from the LAST X register (using \square) — the stack *usually* lifts first. The stack does *not* lift if the last key pressed before a number is entered was one of the following: \square , \square , \square , \square , \square or \square .* If one of these keys was the last key pressed, the number in the displayed X-register is replaced when a new number is entered.

Rearranging Numbers in the Stack

The \square key

Pressing \square exchanges the numbers in the X- and Y-registers.

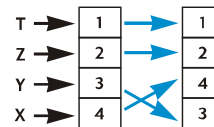

Certain functions (\square , \square , \square , \square , \square , \square , \square , \square , \square , \square , and \square) return answers to the Y-register as well as to the displayed X-register. The \square key, since it exchanges the number in the Y-register with that in the displayed X-register, is used to display the second number calculated.

The \square Key

When \square (roll down) is pressed the number in each stack register is copied into the register below, and the number formerly in the X-register is copied into the T-register.

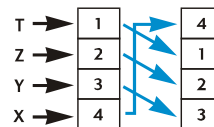

* In addition, the stack does not lift when a number is entered if the last operation performed was storing a number into a financial register. For example, the stack will *not* lift when a number is entered following the sequence 100000 \square , but *will* lift when a number is entered following the sequence 100000 \square \square . Note also that although the stack lifts when \square is pressed, it does not lift *when a number is entered* after \square is pressed.

Pressing $\boxed{R\downarrow}$ four times successively displays the numbers in the Y-, Z-, and T-registers and returns the numbers to their original registers.

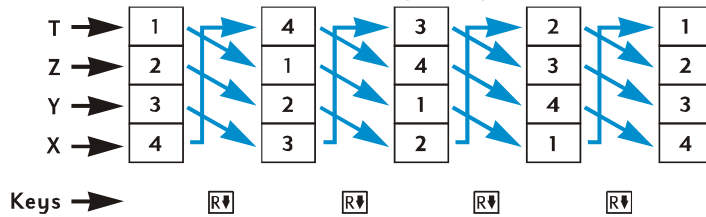

One-Number Functions and the Stack

One-number mathematics and number-alteration functions — $\boxed{1/x}$, $\boxed{\sqrt{x}}$, $\boxed{\ln}$, $\boxed{e^x}$, $\boxed{n!}$, \boxed{RND} , \boxed{INTG} , and \boxed{FRAC} — use only the number in the displayed X-register. When the key is pressed, the function is performed upon the number in the X-register, and the answer is then placed into the X-register. The stack does not lift, so the number formerly in the X-register does not get copied into the Y-register; but this number is copied into the LAST X register. The numbers in the Y-, Z-, and T-registers are not affected when a one number function is performed.

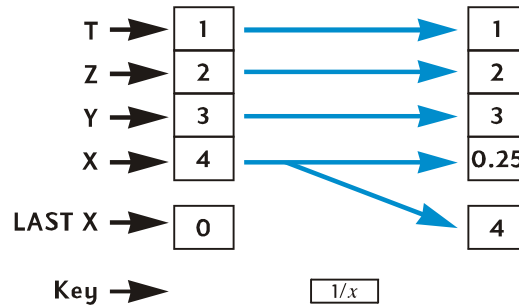

Two-Number Functions and the Stack

Two-number functions — $\boxed{+}$, $\boxed{-}$, $\boxed{\times}$, $\boxed{\div}$, $\boxed{y^x}$, $\boxed{\%}$, $\boxed{\Delta\%}$, and $\boxed{\%T}$ — use the numbers in both the X- and the Y-registers.

Mathematics Functions

To perform an arithmetic operation, the numbers are positioned in the X- and Y-registers just as you would write them vertically on paper: the number you would write on top goes in the Y-register, and the number you would write on the bottom goes in the X-register. For example, to do each of the four arithmetic calculations shown below, you would put the 8 in the Y-register (using \boxed{ENTER}) and then key the 2 into the displayed X-register.)

174 Appendix A: The Automatic Memory Stack

Addition	Subtraction	Multiplication	Division
8 +2 —	8 -2 —	8 ×2 —	8 — 2

When an arithmetic operation or y^x is performed, the answer is placed in the X-register, the number formerly in the X-register is copied into the LAST X register, and the stack *drops*. When the stack drops, the number in the Z-register is copied into the Y-register, and the number in the T-register is copied into the Z-register *but also* remains in the T-register.

The diagram on the next page illustrates the stack operation when $8 \div 2$ is calculated. (Assume that the stack and LAST X registers have already been loaded with the numbers shown as the result of previous calculations.)

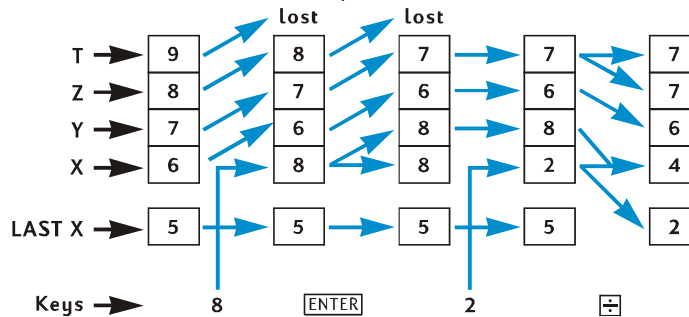

Percentage Functions

When any of the three percentage functions is performed, the answer is placed in the X-register, the number formerly in the X-register is copied into the LAST X register, but the stack does not drop. The numbers in the Y-, Z-, and T-registers are not changed when a percentage function is performed.

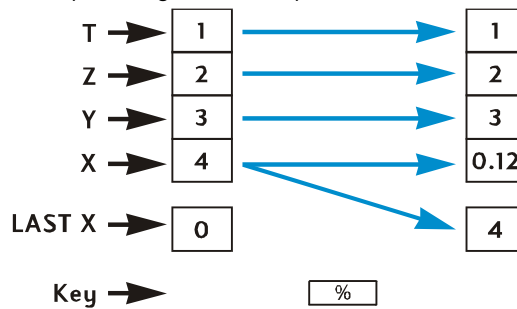

Calendar and Financial Functions

The following table shows what quantity is in each stack register after the indicated calendar or financial function key is pressed. The symbols *x*, *y*, *z*, and *t* represent the number that was in the corresponding register (X, Y, Z, or T, respectively) at the time the function key was pressed.

Register	DATE	ΔDYS	INT	n, i, PV, PMT, FV, NPV, IRR*	AMORT
T	t	t	x	t	y
Z	t	z	INT_{365}	z	x (number of payments)
Y	z	$\Delta DYS_{30\text{-day}}$	-PV	y	PMT_{PRN}
X	DATE	ΔDYS_{actual}	INT_{360}	n, i, PV, PMT, FV, NPV, IRR	PMT_{INT}

Register	PRICE	YTM	SL, SOYD, DB
T	y (settlement date)	z	y
Z	x (maturity date)	y (settlement date)	x (number of year)
Y	INT	x (maturity date)	RDV (remaining depreciable value)
X	PRICE	YTM	DEP

* For n, i, PV, PMT, and FV, the stack registers hold the quantities shown if the key is pressed to calculate the corresponding quantity rather than to merely store a number in the corresponding register.

The LAST X Register and the $\boxed{\text{LSTx}}$ Key

The number in the displayed X-register is copied into the **LAST X** register whenever any of the following function keys is pressed:

$\boxed{+}$	$\boxed{-}$	$\boxed{\times}$	$\boxed{\div}$	$\boxed{1/x}$
$\boxed{y^x}$	$\boxed{e^x}$	$\boxed{\text{LN}}$	$\boxed{\sqrt{x}}$	$\boxed{\text{RND}}$
$\boxed{\text{FRAC}}$	$\boxed{\text{INTG}}$	$\boxed{\Sigma+}$	$\boxed{\Sigma-}$	$\boxed{\hat{x},r}$
$\boxed{\hat{y},r}$	$\boxed{n!}$	$\boxed{\%}$	$\boxed{\Delta\%}$	$\boxed{\%T}$
$\boxed{\text{DATE}}$	$\boxed{\Delta\text{DYS}}$			

Pressing $\boxed{9}$ $\boxed{\text{LSTx}}$ lifts the stack (unless $\boxed{\text{ENTER}}$, $\boxed{\text{CLx}}$, $\boxed{\Sigma+}$, $\boxed{\Sigma-}$, $\boxed{12x}$, or $\boxed{12\div}$ was the last key pressed, as described on page 172), then copies the number from the LAST X register into the displayed X-register. The number remains also in the LAST X register.

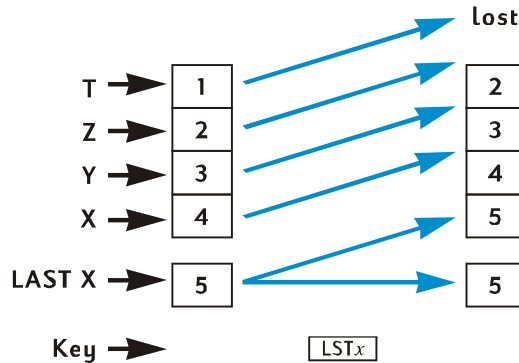

Chain Calculations

The automatic stack lift and stack drop make it possible to do chain calculations without the necessity for keying in parentheses or storing intermediate results, as are required on some other calculators. An intermediate result in the displayed X-register is automatically copied into the Y-register when a number is keyed in after a function key is pressed.* Therefore, when a two-number function key is then pressed, that function is performed using the number keyed into the displayed X-register and the intermediate result in the Y-register. The number then in the Y-register, if remaining as an intermediate result from an earlier calculation, can then be used with the intermediate result in the X-register for another calculation.

* Except for $\boxed{\text{ENTER}}$, $\boxed{\text{CLx}}$, $\boxed{\Sigma+}$, $\boxed{\Sigma-}$, $\boxed{12x}$ or $\boxed{12\div}$, and — under certain circumstances — \boxed{n} , \boxed{i} , $\boxed{\text{PV}}$, $\boxed{\text{PMT}}$, and $\boxed{\text{FV}}$. For more information, refer to Stack Lift, page 172.

The diagram on page 171 illustrates how the automatic stack lift and stack drop make chain calculations quick and error-free.

Virtually every chain calculation you are likely to encounter can be done using only the four stack registers. However, to avoid having to store an intermediate result in a storage register, you should begin every chain calculation at the innermost number or pair of parentheses and then work outward — just as you would if you were doing the calculation manually (that is, using pencil and paper). For example, consider the calculation of

$$3 [4 + 5 (6 + 7)]$$

If this calculation were done from left to right — as were the (simpler) examples under Chain Calculations on page 20 and page 22 — you would have to enter five numbers into the calculator before doing the first operation possible (6 + 7). But since the stack holds only four numbers, this calculation *cannot* be done left-to-right. However, it can easily be done if you begin with the calculation in the innermost pair of parentheses — again, (6 + 7).

Keystrokes	Display	
6 ENTER 7 +	13 . 00	Intermediate result of (6+7).
5 X	65 . 00	Intermediate result of 5 (6+7).
4 +	69 . 00	Intermediate result of [4 + 5(6 + 7)].
3 X	207 . 00	Final result: 3 [4 + 5 (6 + 7)].

Arithmetic Calculations with Constants

Because the number in the T-register remains there when the stack drops, this number can be used as a constant in arithmetic operations. To place the constant into the T-register, key it into the display (that is, into the X-register), then press **ENTER** three times. This also places the constant in the Y and Z-registers. Each time an arithmetic operation is then performed — using the constant in the Y-register and a number keyed into the displayed X-register — the constant will be “dropped” back into the Y-register.

Example: The annual sales of solar engineering hardware your firm — currently \$84,000 — are projected to double each year for the next 3 years. Calculate the annual sales for each of those years.

Keystrokes	Display	
2 ENTER ENTER ENTER	2 . 00	Enters constant into Y, Z, and T-registers.

178 Appendix A: The Automatic Memory Stack

Keystrokes	Display	
84000	84,000.	Enters base amount into displayed X-register.
<input type="checkbox"/> X	168,000.00	Annual sales after first year.
<input type="checkbox"/> X	336,000.00	Annual sales after second year.
<input type="checkbox"/> X	672,000.00	Annual sales after third year.

In the example above, the constant was repeatedly multiplied by the result of the previous operation, which was already in the displayed X-register. In another class of calculations with constants, the constant is multiplied by (or added to, etc.) a new number keyed into the displayed X-register. For these calculations, you must press CLX before keying in a new number after having pressed an operator key. If this were not done, the stack would lift when you keyed in a new number after pressing the operator key, and the Y-register would no longer contain the constant. (Recall — from page 172 — that the stack does not lift when a number is keyed into the displayed X-register after CLX is pressed.)

Example: At Permex Pipes a certain pipe fitting is packaged in quantities of 15, 75, and 250. If the cost per fitting is \$4.38, calculate the cost of each package.*

Keystrokes	Display	
4.38 <input type="checkbox"/> ENTER <input type="checkbox"/> ENTER		
<input type="checkbox"/> ENTER	4.38	Enters constant into Y-, Z-, and T-registers.
15	15.	Enters first quantity into displayed X-register.
<input type="checkbox"/> X	65.70	Cost of a package of 15.
<input type="checkbox"/> CLX 75	75.	Clears display and enters second quantity into displayed X-register.
<input type="checkbox"/> X	328.50	Cost of a package of 75.
<input type="checkbox"/> CLX 250	250.	Clears display and enters third quantity into displayed X-register.
<input type="checkbox"/> X	1,095.00	Cost of a package of 250.

* You may want to compare this method of arithmetic calculations with constants to the method using LSTX described on page 74.

Appendix B

More About IRR

Given a sequence of positive and negative cash flows, we hope that there is enough information to determine whether an *IRR* answer exists, and what that answer is. For the vast majority of cases, your hp 12c will find the unique *IRR* answer if it exists. But the *IRR* computation is so complex that if the cash flow sequence does not meet certain criteria, then sometimes the calculator is unable to determine whether or not an answer or answers exist.

Let's look at all of the possible outcomes of *IRR* as calculated by your hp 12c:

Case 1: A positive answer. If a positive answer is displayed, it is the only such answer. One or more negative answers may also exist.

Case 2: A negative answer. If a negative answer is displayed, there *may* be additional negative answers, and there *may* be a single positive answer. If additional answers (negative or positive) exist, they can be calculated using the procedure described below.

Case 3: The calculator displays **Error 3**. This indicates that the computation is very complex, possibly involving multiple answers, and cannot be continued until you give the calculator an estimate of *IRR*. The procedure for doing so is described below.

Case 4: The calculator displays **Error 7**. This indicates that there is no answer to the computation of *IRR* with the cash flow amounts you have entered. This situation is probably the result of a mistake in entering the magnitudes or signs of the cash flows or the number of times a cash flow amount occurs consecutively. Refer to Reviewing Cash Flow Entries (page 64) and Changing Cash Flow Entries (page 65) to check and correct the entries. **Error 7** will result if there is not at least one positive cash flow *and* at least one negative cash flow.

Although the calculator will eventually reach one of the above outcomes, it may take a long time to get there. You may wish to terminate the *IRR* iterative process, by pressing any key, to see what interest rate the calculator has computed at that point. If you stop the calculation, you may continue searching for *IRR* as described below.

Searching for IRR. You can continue searching for *IRR* solutions, even after an **Error 3** indication, as follows:

1. Make a guess for the interest rate and key it in.
2. Press **RCL** **9** **R/S**.

180 Appendix B: More About IRR

Your guess will aid the calculator in its search, and if it finds an *IRR* answer near your guess, that answer will be displayed. Since the calculator cannot tell you the number of solutions that exist when there is more than one mathematically correct answer, you can continue to make guesses, pressing $\boxed{\text{RCL}} \boxed{9} \boxed{\text{R/S}}$ after each one, to search for *IRR* solutions.

You can hasten this process by using the $\boxed{\text{NPV}}$ function to help you make a good guess. Remember that a correct *IRR* solution will make the calculated *NPV* very small. So continue to guess interest rates and solve for *NPV* until the answer you obtain is reasonably close to zero. Then press $\boxed{\text{RCL}} \boxed{9} \boxed{\text{R/S}}$ to calculate the *IRR* answer near your guess.

How would this work in case 2 above? The calculator displays a negative answer and you wish to check for a unique positive *IRR*. Key in successively larger guesses for i (starting from 0) and solve for *NPV* until you reach a sign change in your *NPV* outcomes. Then press $\boxed{\text{RCL}} \boxed{9} \boxed{\text{R/S}}$ to find an *IRR* solution near the last interest rate obtained using the $\boxed{\text{NPV}}$ key.

If you stop the *IRR* iterative process, you can test the interest obtained using $\boxed{\text{NPV}}$, and then restart the process by pressing $\boxed{\text{RCL}} \boxed{9} \boxed{\text{R/S}}$.

Appendix C

Error Conditions

Some calculator operations cannot be performed under certain conditions (for example, \div when $x = 0$). If you attempt such an operation under these conditions, the calculator will display the word **Error** followed by a digit, **0** through **9**. Listed below are operations that cannot be performed under the conditions specified. The symbols x and y represent the number in the X- and Y-registers, respectively, when the operation key is pressed.

Error 0: Mathematics

Operation	Condition
\div	$x = 0$
$\frac{1}{x}$	$x = 0$
\sqrt{x}	$x < 0$
LN	$x \leq 0$
y^x	$y = 0$ and $x \leq 0$ $y < 0$ and x is noninteger.
$\Delta\%$	$y = 0$
$\%T$	$y = 0$
STO \div (0 through 4)	$x = 0$
$n!$	x is noninteger $x < 0$

182 Appendix C: Error Conditions

Error 1: Storage Register Overflow

Operation	Condition
$\boxed{\text{STO}} \boxed{+}$ (0 through 4) $\boxed{\text{STO}} \boxed{-}$ (0 through 4) $\boxed{\text{STO}} \boxed{\times}$ (0 through 4) $\boxed{\text{STO}} \boxed{\div}$ (0 through 4) $\boxed{12\text{X}}$	Magnitude of result is greater than $9.999999999 \times 10^{99}$.

Error 2: Statistics

Operation	Condition
$\boxed{\bar{x}}$	n (number in R_1) = 0
$\boxed{\bar{x}_w}$	$\Sigma x = 0$
\boxed{s}	$n = 0$ $n = 1$ $n\Sigma x^2 - (\Sigma x)^2 < 0$ $n\Sigma y^2 - (\Sigma y)^2 < 0$
$\boxed{\hat{y}_r}$	$n = 0$ $n\Sigma x^2 - (\Sigma x)^2 = 0$
$\boxed{\hat{x}_r}$	$n = 0$ $n\Sigma y^2 - (\Sigma y)^2 = 0$
$\boxed{\hat{y}_r} \boxed{\times \hat{y}}$ $\boxed{\hat{x}_r} \boxed{\times \hat{x}}$	$[n\Sigma x^2 - (\Sigma x)^2][n\Sigma y^2 - (\Sigma y)^2] \leq 0$

Error 3: IRR

Refer to Appendix B.

Error 4: Memory

- Attempting to enter more than 99 program lines.
- Attempting to $\boxed{\text{GTO}}$ to a program line that does not exist.
- Attempting storage register arithmetic in R_5 through R_9 or R_0 through R_9 .

Error 5: Compound Interest

Operation	Condition
n	$PMT \leq -PV \times i$ $PMT = FV \times i$ $i \leq -100$ The values in i , PV , and FV are such that no solution exists for n .
i	$PMT = 0$ and $n < 0$ Cash flows all have same sign.
PV	$i \leq -100$
PMT	$n = 0$ $i = 0$ $i \leq -100$
FV	$i \leq -100$
$AMORT$	$x \leq 0$ x is noninteger.
NPV	$i \leq -100$
SL $SOYD$ DB	$n \leq 0$ $n > 10^{10}$ $x \leq 0$ x is noninteger

Error 6: Storage Registers

Operation	Condition
STO RCL	Storage register specified does not exist or has been converted to program lines.
CFj Nj	n specifies a storage register that does not exist or has been converted to program lines.
NPV IRR	$n > 20$ $n > r$ (as defined by MEM) $n < 0$ n is noninteger
Ni	$x > 99$ $x < 0$ x is noninteger

184 Appendix C: Error Conditions

Error 7: IRR

Refer to Appendix B.

Error 8: Calendar

Operation

ADYS

DATE

DATE

PRICE

YTM

Condition

Improper date format or illegal date.

Attempting to add days beyond calculator's date capacity.

Improper date format or illegal date.

More than 500 years between settlement (purchase) date and maturity (redemption) date.

Maturity date earlier than settlement date.

Maturity date has no corresponding coupon date (6 months earlier).*

Error 9: Service

Refer to Appendix E.

Pr Error

- Continuous Memory has been reset. (Refer to Continuous Memory, page 70.)
- You have reset the calculator using the reset hole (see page 194).

* This is the case for the 31st of March, May, August, October, and December, plus August 29 (except in a leap year) and 30. For example, there is no September 31, so March 31 has no corresponding coupon date 6 months earlier.

To correct this problem for all maturity dates except August 29 and 30, add one day to *both* the settlement date *and* the maturity date in your calculations. For instance, if a bond were purchased on June 1, 2004 (the settlement date) with a maturity date of December 31, 2005, you should change the dates to June 2, 2004 and January 1, 2006 for your calculations.

For August 29 and 30, there is no calculator solution that gives the correct answer.

Appendix D

Formulas Used

Percentage

$$\% = \frac{\text{Base}(y) \times \text{Rate}(x)}{100}$$

$$\Delta\% = 100 \left(\frac{\text{NewAmount}(x) - \text{Base}(y)}{\text{Base}(y)} \right)$$

$$\%T = 100 \left(\frac{\text{Amount}(x)}{\text{Total}(y)} \right)$$

Interest

n = number of compounding periods.

i = periodic interest rate, expressed as a decimal.

PV = present value.

FV = future value or balance.

PMT = periodic payment.

S = payment mode factor (0 or 1) indicating treatment of PMT .
0 corresponds to End, 1 to Begin.

I = interest amount.

$\text{INTG}(n)$ = integer portion of n .

$\text{FRAC}(n)$ = fractional portion of n .

Simple Interest

$$I_{360} = \frac{n}{360} \times PV \times i$$

$$I_{365} = \frac{n}{365} \times PV \times i$$

186 Appendix D: Formulas Used

Compound Interest

Without an odd period:

$$0 = PV + (1 + iS) \cdot PMT \cdot \left[\frac{1 - (1 + i)^{-n}}{i} \right] + FV(1 + i)^{-n}$$

With simple interest used for an odd period:

$$0 = PV[1 + i\text{FRAC}(n)] + (1 + iS)PMT \left[\frac{1 - (1 + i)^{-\text{INTG}(n)}}{i} \right] + FV(1 + i)^{-\text{INTG}(n)}$$

With compound interest used for an odd period:

$$0 = PV(1 + i)^{\text{FRAC}(n)} + (1 + iS)PMT \left[\frac{1 - (1 + i)^{-\text{INTG}(n)}}{i} \right] + FV(1 + i)^{-\text{INTG}(n)}$$

Amortization

n = number of payment periods to be amortized.

INT_j = amount of PMT applied to interest in period j .

PRN_j = amount of PMT applied to principal in period j .

PV_j = present value (balance) of loan after payment in period j .

j = period number.

INT_1 = {0 if $n = 0$ and payment mode is set to Begin.
 $|PV_0 \times i|_{\text{RND}}$ (sign of PMT)

$PRN_1 = PMT - INT_1$

$PV_1 = PV_0 + PRN_1$

$INT_j = |PV_{j-1} \times i|_{\text{RND}} \times (\text{sign of } PMT)$ for $j > 1$.

$PRN_j = PMT - INT_j$

$PV_j = PV_{j-1} + PRN_j$

$$\sum INT = \sum_{i=1}^n INT_i = INT_1 + INT_2 + \dots + INT_n$$

$$\sum PRN = \sum_{i=1}^n PRN_i = PRN_1 + PRN_2 + \dots + PRN_n$$

$$PV_n = PV_0 + \sum PRN$$

Discounted Cash Flow Analysis

Net Present Value

NPV = net present value of a discounted cash flow.

CF_j = cash flow at period j .

$$NPV = CF_0 + \frac{CF_1}{(1+i)^1} + \frac{CF_2}{(1+i)^2} + \dots + \frac{CF_n}{(1+i)^n}$$

Internal Rate of Return

n = number of cash flows

CF_j = cash flow at period j .

IRR = Internal Rate of Return

$$0 = \sum_{j=1}^k CF_j \cdot \left[\frac{1 - (1 + IRR)^{-n_j}}{IRR} \right] \cdot \left[(1 + IRR)^{-\sum_{q<j} n_q} \right] + CF_0$$

Calendar

Actual Day Basis

$$\Delta DYS = f(DT_2) - f(DT_1)$$

where

$$f(DT) = 365 (yyyy) + 31 (mm - 1) + dd + INTG (z/4) - x$$

and

for $mm \leq 2$

$$x = 0$$

$$z = (yyyy) - 1$$

for $mm > 2$

$$x = INTG (0.4mm + 2.3)$$

$$z = (yyyy)$$

INTG = Integer portion.

Note: Additional tests are performed in order to ensure that the century (but not millennium) years are not considered leap years.

30/360 Day Basis

$$DAYS = f(DT_2) - f(DT_1)$$

$$f(DT) = 360 (yyyy) + 30mm + z$$

for $f(DT_1)$

$$\text{if } dd_1 = 31 \text{ then } z = 30$$

$$\text{if } dd_1 \neq 31 \text{ then } z = dd_1$$

for $f(DT_2)$

$$\text{if } dd_2 = 31 \text{ and } dd_1 = 30 \text{ or } 31 \text{ then } z = 30$$

$$\text{if } dd_2 = 31 \text{ and } dd_1 < 30 \text{ then } z = dd_2$$

$$\text{if } dd_2 < 31 \text{ then } z = dd_2$$

188 Appendix D: Formulas Used

Bonds

Reference:

Spence, Graudenz, and Lynch, *Standard Securities Calculation Methods*, Securities Industry Association, New York, 1973.

DIM = days between issue date and maturity date.

DSM = days between settlement date and maturity date.

DCS = days between beginning of current coupon period and settlement date.

E = number of days in coupon period where settlement occurs.

DSC = $E - DCS$ = days from settlement date to next 6-month coupon date.

N = number of semiannual coupons payable between settlement date and maturity date.

CPN = annual coupon rate (as a percentage).

$YIELD$ = annual yield (as a percentage).

$PRICE$ = dollar price per \$100 par value.

RDV = redemption value.

For semiannual coupon with 6 months or less to maturity:

$$PRICE = \left[\frac{100(RDV + \frac{CPN}{2})}{100 + (\frac{DSM}{E} \times \frac{YIELD}{2})} \right] - \left[\frac{DCS}{E} \times \frac{CPN}{2} \right]$$

For semiannual coupon with more than 6 months to maturity:

$$PRICE = \left[\frac{RDV}{\left(1 + \frac{YIELD}{200}\right)^{N-1+\frac{DSC}{E}}} \right] + \left[\sum_{K=1}^N \frac{\frac{CPN}{2}}{\left(1 + \frac{YIELD}{200}\right)^{K-1+\frac{DSC}{E}}} \right] - \left[\frac{CPN}{2} \times \frac{DCS}{E} \right]$$

Depreciation

- L = asset's useful life expectancy.
 SBV = starting book value.
 SAL = salvage value.
 $FACT$ = declining-balance factor expressed as a percentage.
 j = period number.
 DPN_j = depreciation expense during period j .
 RDV_j = remaining depreciable value at end of period j
 $= RDV_{j-1} - DPN_j$ where $RDV_0 = SBV - SAL$
 RBV_j = remaining book value = $RBV_{j-1} - DPN_j$ where $RBV_0 = SBV$
 Y_1 = number of months in partial first year.

Straight-Line Depreciation

Keyboard function:

$$DPN_j = \frac{SBV - SAL}{L} \text{ for } j = 1, 2, \dots, L$$

Program for partial first year:

$$DPN_1 = \frac{SBV - SAL}{L} \cdot \frac{Y_1}{12}$$

$$DPN_j = \frac{SBV - SAL}{L} \text{ for } j = 2, 3, \dots, L$$

$$DPN_{L+1} = RDV_L$$

Sum-of-the-Years-Digits Depreciation

$$SOYD_k = \frac{(W + 1)(W + 2F)}{2}$$

where W = integer part of k

F = fractional part of k .

(i.e., for $k = 12.25$ years, $W = 12$ and $F = 0.25$).

Keyboard function:

$$DPN_j = \frac{(L - j + 1)}{SOYD_L} \cdot (SBV - SAL)$$

190 Appendix D: Formulas Used

Program for partial year:

$$DPN_1 = \left(\frac{L}{SOYD} \right) \cdot \left(\frac{Y_1}{12} \right) \cdot (SBV - SAL)$$

$$DPN_j = \left(\frac{LADJ - j + 2}{SOYD_{LADJ}} \right) \cdot (SBV - D_1 - SAL) \quad \text{for } j \neq 1$$

$$\text{where } LADJ = L - \left(\frac{Y_1}{12} \right)$$

Declining-Balance Depreciation

Keyboard function:

$$DPN_j = RBV_{j-1} \cdot \frac{FACT}{100L} \quad \text{for } j = 1, 2, \dots, L$$

Program for partial first year:

$$DPN_1 = SBV \cdot \frac{FACT}{100L} \cdot \frac{Y_1}{12}$$

$$DPN_j = RBV_{j-1} \cdot \frac{FACT}{100L} \quad \text{for } j \neq 1$$

Modified Internal Rate of Return

n = number of compounding periods.

NFV_p = Net future value of the positive cash flows.

NPV_N = Net present value of the negative cash flows.

$$MIRR = 100 \left[\left(\frac{NFV_p}{-NPV_N} \right)^{\frac{1}{n}} - 1 \right]$$

Advance Payments

A = number of payments made in advance.

$$PMT = \frac{PV - FV(1+i)^{-n}}{\left[\frac{1 - (1+i)^{-(n-A)}}{i} + A \right]}$$

Interest Rate Conversions

C = number of compounding periods per year.

EFF = the effective annual interest rate as a decimal.

NOM = the nominal annual interest rate as a decimal.

Finite Compounding

$$EFF = \left(1 + \frac{NOM}{C}\right)^C - 1$$

Continuous Compounding

$$EFF = (e^{NOM} - 1)$$

Statistics**Mean**

$$\bar{x} = \frac{\sum x}{n} \quad \bar{y} = \frac{\sum y}{n}$$

Weighted Mean

$$\bar{x}_w = \frac{\sum wx}{\sum w}$$

Linear Estimation

n = number of data pairs

$$\hat{y} = A + Bx$$

$$\hat{x} = \frac{y - A}{B}$$

$$\text{where } B = \frac{\sum xy - \frac{\sum x \cdot \sum y}{n}}{\sum x^2 - \frac{(\sum x)^2}{n}}$$

$$A = \bar{y} - B\bar{x}$$

192 Appendix D: Formulas Used

$$r = \frac{\left[\sum xy - \frac{\sum x \cdot \sum y}{n} \right]}{\sqrt{\left[\sum x^2 - \frac{(\sum x)^2}{n} \right] \cdot \left[\sum y^2 - \frac{(\sum y)^2}{n} \right]}}$$

Standard Deviation

$$s_x = \sqrt{\frac{n \sum x^2 - (\sum x)^2}{n(n-1)}} \quad s_y = \sqrt{\frac{n \sum y^2 - (\sum y)^2}{n(n-1)}}$$

Factorial

$$0! = 1$$

For $n > 1$ where n is an integer:

$$n! = \prod_{i=1}^n i$$

The Rent or Buy Decision

$$\text{Market Value} = \text{PRICE}(1 + I)^n$$

where:

I = appreciation per year (as decimal)

n = number of years

$$\text{Net Cash Proceeds on Resale} = \text{Market Value} - \text{Mortgage Balance} - \text{Commission}$$

The interest rate is obtained by solving the financial (compound interest) equation for i using:

n = number of years house is owned

PV = down payment + closing costs

PMT = mortgage payment + taxes + maintenance - rent - (% tax)
(interest + taxes)

FV = net cash proceeds on resale

$$\text{Annual interest rate} = 12 \times i$$

Appendix E

Battery, Warranty, and Service Information

Battery

The hp 12c is shipped with one 3 Volt CR2023 Lithium battery. Battery life depends on how the calculator is used. If the calculator is being used to perform operations other than running programs, it uses much less power.

Low-Power Indication

A battery symbol (*) shown in the upper-left corner of the display when the calculator is on signifies that the available battery power is running low. When the battery symbol begins flashing, replace the battery as soon as possible to avoid losing data.

Use only a fresh battery. Do not use rechargeable batteries.

Warning



There is the danger of explosion if the battery is incorrectly replaced. Replace only with the same or equivalent type recommended by the manufacturer. Dispose of used batteries according to the manufacturer's instructions. Do not mutilate, puncture, or dispose of batteries in fire. The batteries can burst or explode, releasing hazardous chemicals. Replacement battery is a Lithium 3V Coin Type CR2032.

Installing a New Battery

The contents of the calculator's Continuous Memory are preserved for a short time while the battery is out of the calculator (provided that you turn off the calculator before removing the battery). This allows you ample time to replace the battery without losing data or programs. If the battery is left out of the calculator for an extended period, the contents of Continuous Memory may be lost.

194 Appendix E: Battery, Warranty, and Service Information

To install a new battery, use the following procedure:

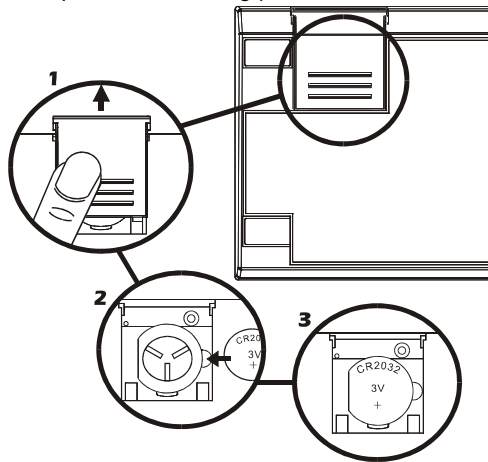

1. With the calculator turned off, slide the battery cover off.
2. Remove the old battery.
3. Insert a new battery, with positive polarity facing outward.
4. Replace the battery cover.

Note: Be careful not to press any keys while the battery is out of the calculator. If you do so, the contents of Continuous Memory may be lost and keyboard control may be lost (that is, the calculator may not respond to keystrokes).

5. Replace the battery compartment cover and press **[ON]** to turn on the power. If for any reason Continuous Memory has been reset (that is, if its contents have been lost), the display will show **Pr Error**. Pressing any key will clear this message.

Verifying Proper Operation (Self-Tests)

If it appears that the calculator will not turn on or otherwise is not operating properly, use one of the following procedures.

For a calculator that does respond to keystrokes:

1. With the calculator off, hold down the **[ON]** key and press **[X]**.
2. Release the **[ON]** key, then release the **[X]** key. This initiates a complete test of the calculator's electronic circuitry. If everything is working correctly, within about 25 seconds (during which the word **running** flashes) the display should show **-8,8,8,8,8,8,8,8,8**, and all of the status indicators (except

the * battery power indicator) should turn on.* If the display shows **Error 9**, goes blank, or otherwise does not show the proper result, the calculator requires service.†

Note: Tests of the calculator's electronics are also performed if the \oplus key or the \div key is held down when ON is released.‡ These tests are included in the calculator to be used in verifying that it is operating properly during manufacturing and service.

If you had suspected that the calculator was not working properly but the proper display was obtained in step 2, it is likely that you made an error in operating the calculator. We suggest you reread the section in this handbook applicable to your calculation — including, if appropriate, appendix A. If you still experience difficulty, write or telephone Hewlett-Packard at an address or phone number listed under Service (Page 197).

* The status indicators turned on at the end of this test include some that normally are not displayed on the hp 12c.

† If the calculator displays **Error 9** as a result of the ON/\times test or the ON/\oplus test but you wish to continue using your calculator, you should reset Continuous Memory as described on page 70.

‡ The ON/\oplus combination initiates a test that is similar to that described above, but continues indefinitely. The test can be terminated by pressing any key, which will halt the test within 25 seconds. The ON/\div combination initiates a test of the keyboard and the display. When the ON key is released, certain segments in the display will be lit. To run the test, the keys are pressed in order from left to right along each row, from the top row to the bottom row. As each key is pressed, different segments in the display are lit. If the calculator is operating properly *and all the keys are pressed in the proper order*, the calculator will display **12** after the last key is pressed. (The ENTER key should be pressed both with the third-row keys and with the fourth-row keys.) If the calculator is not working properly, *or if a key is pressed out of order*, the calculator will display **Error 9**. *Note that if this error display results from an incorrect key being pressed, this does not indicate that your calculator requires service.* This test can be terminated by pressing any key out of order (which will, of course, result in the **Error 9** display). Both the **Error 9** display and the **12** display can be cleared by pressing any key.

Warranty

hp 12c Financial Calculator; Warranty period: 12 months

1. HP warrants to you, the end-user customer, that HP hardware, accessories and supplies will be free from defects in materials and workmanship after the date of purchase, for the period specified above. If HP receives notice of such defects during the warranty period, HP will, at its option, either repair or replace products which prove to be defective. Replacement products may be either new or like-new.
2. HP warrants to you that HP software will not fail to execute its programming instructions after the date of purchase, for the period specified above, due to defects in material and workmanship when properly installed and used. If HP receives notice of such defects during the warranty period, HP will replace software media which does not execute its programming instructions due to such defects.
3. HP does not warrant that the operation of HP products will be uninterrupted or error free. If HP is unable, within a reasonable time, to repair or replace any product to a condition as warranted, you will be entitled to a refund of the purchase price upon prompt return of the product.
4. HP products may contain remanufactured parts equivalent to new in performance or may have been subject to incidental use.
5. Warranty does not apply to defects resulting from (a) improper or inadequate maintenance or calibration, (b) software, interfacing, parts or supplies not supplied by HP, (c) unauthorized modification or misuse, (d) operation outside of the published environmental specifications for the product, or (e) improper site preparation or maintenance.
6. HP MAKES NO OTHER EXPRESS WARRANTY OR CONDITION WHETHER WRITTEN OR ORAL. TO THE EXTENT ALLOWED BY LOCAL LAW, ANY IMPLIED WARRANTY OR CONDITION OF MERCHANTABILITY, SATISFACTORY QUALITY, OR FITNESS FOR A PARTICULAR PURPOSE IS LIMITED TO THE DURATION OF THE EXPRESS WARRANTY SET FORTH ABOVE. Some countries, states or provinces do not allow limitations on the duration of an implied warranty, so the above limitation or exclusion might not apply to you. This warranty gives you specific legal rights and you might also have other rights that vary from country to country, state to state, or province to province.
7. TO THE EXTENT ALLOWED BY LOCAL LAW, THE REMEDIES IN THIS WARRANTY STATEMENT ARE YOUR SOLE AND EXCLUSIVE REMEDIES. EXCEPT AS INDICATED ABOVE, IN NO EVENT WILL HP OR ITS SUPPLIERS BE LIABLE FOR LOSS OF DATA OR FOR DIRECT, SPECIAL, INCIDENTAL, CONSEQUENTIAL (INCLUDING LOST PROFIT OR DATA), OR OTHER DAMAGE, WHETHER BASED IN CONTRACT, TORT, OR OTHERWISE.

Some countries, States or provinces do not allow the exclusion or limitation of incidental or consequential damages, so the above limitation or exclusion may not apply to you.

8. The only warranties for HP products and services are set forth in the express warranty statements accompanying such products and services. Nothing herein should be construed as constituting an additional warranty. HP shall not be liable for technical and editorial errors or omissions contained herein.

FOR CONSUMER TRANSACTIONS IN AUSTRALIA AND NEW ZEALAND: THE WARRANTY TERMS CONTAINED IN THIS STATEMENT, EXCEPT TO THE EXTENT LAWFULLY PERMITTED, DO NOT EXCLUDE, RESTRICT OR MODIFY AND ARE IN ADDITION TO THE MANDATORY STATUTORY RIGHTS APPLICABLE TO THE SALE OF THIS PRODUCT TO YOU.

Service

Europe

Country :	Telephone numbers
Austria	+43-1-3602771203
Belgium	+32-2-7126219
Denmark	+45-8-2332844
Eastern Europe countries	+420-5-41422523
Finland	+35-89640009
France	+33-1-49939006
Germany	+49-69-95307103
Greece	+420-5-41422523
Holland	+31-2-06545301
Italy	+39-02-75419782
Norway	+47-63849309
Portugal	+351-229570200
Spain	+34-915-642095
Sweden	+46-851992065
Switzerland	+41-1-4395358 (German) +41-22-8278780 (French) +39-02-75419782 (Italian)
Turkey	+420-5-41422523
UK	+44-207-4580161
Czech Republic	+420-5-41422523
South Africa	+27-11-2376200
Luxembourg	+32-2-7126219
Other European countries	+420-5-41422523

198 Appendix E: Battery, Warranty, and Service Information

Asia Pacific	Country :	Telephone numbers
	Australia	+61-3-9841-5211
	Singapore	+61-3-9841-5211

L.America	Country :	Telephone numbers
	Argentina	0-810-555-5520
	Brazil	Sao Paulo 3747-7799; ROTC 0-800-157751
	Mexico	Mx City 5258-9922; ROTC 01-800-472-6684
	Venezuela	0800-4746-8368
	Chile	800-360999
	Columbia	9-800-114726
	Peru	0-800-10111
	Central America & Caribbean	1-800-711-2884
	Guatemala	1-800-999-5105
	Puerto Rico	1-877-232-0589
	Costa Rica	0-800-011-0524

N.America	Country :	Telephone numbers
	USA	1800-HP INVENT
	Canada	(905)206-4663 or 800-HP INVENT

ROTC = Rest of the country

Please logon to <http://www.hp.com> for the latest service and support information.

Regulatory Information

This section contains information that shows how the hp 12c financial calculator complies with regulations in certain regions. Any modifications to the calculator not expressly approved by Hewlett-Packard could void the authority to operate the 12c in these regions.

USA

This calculator generates, uses, and can radiate radio frequency energy and may interfere with radio and television reception. The calculator complies with the limits for a Class B digital device, pursuant to Part 15 of the FCC Rules. These limits are designed to provide reasonable protection against harmful interference in a residential installation.

However, there is no guarantee that interference will not occur in a particular installation. In the unlikely event that there is interference to radio or television reception (which can be determined by turning the calculator off and on), the user is encouraged to try to correct the interference by one or more of the following measures:

- Reorient or relocate the receiving antenna.
- Relocate the calculator, with respect to the receiver.

Canada

This Class B digital apparatus complies with Canadian ICES-003.

Cet appareil numérique de la classe B est conforme à la norme NMB-003 du Canada.

Japan

この装置は、情報処理装置等電波障害自主規制協議会(VCCI)の基準に基づく第二情報技術装置です。この装置は、家庭環境で使用することを目的としていますが、この装置がラジオやテレビジョン受信機に近接して使用されると、受信障害を引き起こすことがあります。

取扱説明書に従って正しい取り扱いをしてください。

Temperature Specifications

- Operating: 0° to 55° C (32° to 131° F)
- Storage: -40° to 65° C (-40° to 149° F)

Noise Declaration

In the operator position under normal operation (per ISO 7779): LpA < 70dB.

Disposal of Waste Equipment by Users in Private Household in the European Union



This symbol on the product or on its packaging indicates that this product must not be disposed of with your other household waste. Instead, it is your responsibility to dispose of your waste equipment by handing it over to a designated collection point for the recycling of waste electrical and electronic equipment. The separate collection and recycling of your waste equipment at the time of disposal will help to conserve natural resources and ensure that it is recycled in a manner that protects human health and the environment. For more information about where you can drop off your waste equipment for recycling, please contact your local city office, your household waste disposal service or the shop where you purchased the product.

Appendix F

United Kingdom Calculations

The calculations for most financial problems in the United Kingdom are identical to the calculations for those problems in the United States — which are described earlier in this handbook. Certain problems, however, require different calculation methods in the United Kingdom than in the United States, even though the terminology describing the problems may be similar. Therefore, it is recommended that you ascertain the usual practice in the United Kingdom for the financial problem you are solving.

The remainder of this appendix describes three types of financial calculations for which the conventional practice differs significantly between the United Kingdom and the United States.

Mortgages

The amount of the repayments on home loans and mortgages offered by *banks* in the United Kingdom can usually be calculated as described under Calculating the Payment Amount, page 46. Building Societies in the United Kingdom, however, calculate the amount of these repayments differently. In general, the repayment amount of a Building Society mortgage is calculated as follows: first, the *annual* repayment amount is calculated using the annual interest rate; second, the *periodic* repayment amount is calculated by dividing the annual repayment amount by the number of repayment periods in one year.

Furthermore, the calculations used by Building Societies are rounded; therefore, to match their scale repayment figures you would have to round your calculations accordingly.

202 Appendix F: United Kingdom Calculations

Annual Percentage Rate (APR) Calculations

In the United Kingdom, the calculation of the Annual Percentage Rate of Charge (APR) in accordance with the United Kingdom Consumer Credit Act (1974) differs from the calculation of the APR in the United States. Unlike the practice in the United States, where the APR can be calculated by multiplying the periodic interest rate by the number of periods per year, in the United Kingdom the APR is calculated by converting the periodic interest rate to the "effective annual rate," then truncating the result to one decimal place. With the periodic interest rate in the display and in the **i** register, the effective annual rate can be calculated by keying in the number of compounding periods per year, pressing \boxed{n} , then proceeding with step 4 of the procedure given on page 160 for converting a nominal rate to an effective rate.

Bond Calculations

Solutions for the price and yield to maturity of United Kingdom bonds are not included in this handbook. Actual practice differs according to the type of bond; variations such as cumulative and ex-dividend pricing, simple or compound interest discounting, etc., may be encountered.

Application Notes covering such situations may be available in the United Kingdom; check with your local authorized Hewlett-Packard dealer.

Function Key Index

General

ON Power on /off key (page 16).

f Shift key. Selects alternate function in gold above the function keys (page 16). Also used in display formatting (page 71).

g Shift key. Selects alternate function in blue on the slanted face of the function keys (page 16).

CLEAR^{PREFIX} after **f**, **g**, **STO**, **RCL** or **GTO**, cancels that key (page 18).

f **CLEAR^{PREFIX}** also displays mantissa of number in the displayed X-register (page 73).

Digit Entry

ENTER Enters a copy of number in displayed X-register into Y-register. Used to separate numbers (pages 19 and 171).

CHS Changes sign of number or exponent of 10 in X-register (page 17).

EEX Enter exponent. After pressing, next numbers keyed in are exponents of 10 (page 18).

0 – **9** digits. Used for keying in numbers (page 19) and display formatting (page 71).

. Decimal point (page 17). Also used for display formatting (page 71).

CLX Clears contents of displayed X-register to zero (page 18).

Arithmetic

+ - × ÷ = Arithmetic operators (page 19).

Storage Registers

STO Store. Followed by number key, decimal point and number key, or top row financial key, stores displayed number in storage register specified (page 23). Also used to perform storage register arithmetic (page 24).

RCL Recall. Followed by number key, decimal point and number key, or top-row financial key, recalls value from storage register specified into the displayed X-register (page 23).

CLEAR REG Clears contents of stack (X, Y, Z and T), all storage registers, statistical registers, and financial registers (page 24). Leaves program memory untouched; not programmable.

Percentage

% Computes x% of y and retains the y-value in the Y-register (page 26).

Δ% Computes percent of change between number in Y-register and number in displayed X-register (page 27).

%T Computes percent that x is of number in Y-register (page 28).

Calendar

DMY Sets date format to day-month-year (page 30); not programmable.

M.DY Sets date format to month-day-year (page 29); not programmable.

DATE Changes a date in the Y-register by the number of days in the X-register and displays day of week (page 30).

ADYS Computes the number of days between two dates in the Y and X-registers (page 31).

204 Function Key Index

Financial

CLEAR **[FIN]** Clears contents of financial registers **(page 33)**.

[BEG] Sets payment mode to Begin for compound interest calculations involving payments **(page 37)**.

[END] Sets payment mode to End for compound interest calculations involving payments **(page 37)**.

[INT] Calculates simple interest **(page 33)**.

[n] Stores or computes number of periods in financial problem **(page 32)**.

[12X] Multiplies a number in displayed X-register by 12 and stores the resulting value in the n-register **(page 39)**.

[i] Stores or computes interest rate per compounding period **(page 32)**.

[12÷] Divides number in displayed X-register by 12 and stores the resulting value in the I-register **(page 39)**.

[PV] Stores or computes the present value (that is, the initial cash flow) of a financial problem **(page 32)**.

[PMT] Stores or computes payment amount **(page 32)**.

[FV] Stores or computes future value (final cash flow) of a financial problem **(page 32)**.

[AMORT] Amortizes x number of periods using values stored in PMT, i , PV, and the display. Updates values in PV and n **(page 54)**.

[NPV] Calculates the net present value of up to 20 uneven cash flows and initial investment using values stored with **[CF₀]**, **[CF_i]**, and **[N_i]** **(page 58)**.

[IRR] Calculates the internal rate of return (yield) for up to 20 uneven cash flows and initial investment using values stored with **[CF₀]**, **[CF_i]**, and **[N_i]** **(page 63)**.

[CF₀] Initial cash flow. Stores contents of displayed X-register in R_0 , initializes n to zero, sets N_0 to 1. Used at the beginning of a discounted cash flow problem **(page 58)**.

[CF_i] Cash flow j . Stores the contents of X-register in R_i , increments n by 1, and sets N_i to 1. Used for all cash flows except the initial cash flow in a discounted cash flow problem **(page 58)**.

[SL] Calculates depreciation using straight-line method. **(page 68)**.

[PRICE] Calculates bond price, given desired yield to maturity **(page 67)**.

[YTM] Calculates yield to maturity, given bond price **(page 67)**.

[N_i] Stores the number (from 1 to 99) of times each cash flow occurs as N_i . Assumes 1 unless otherwise specified **(page 61)**.

[SOYD] Calculates depreciation using sum-of-the-years-digits method **(page 68)**.

[DB] Calculates depreciation using declining-balance method **(page 68)**.

Statistics

CLEAR **[Σ]** Clears statistical storage registers R_1 through R_6 and stack registers **(page 76)**.

[Σ+] Accumulates statistics using numbers from X- and Y-registers in storage registers R_1 through R_6 **(page 76)**.

[Σ-] Cancels effect of numbers from X- and Y-registers in storage registers R_1 through R_6 **(page 77)**.

\bar{x} Computes mean (average) of *x-values* and *y-values* using accumulated statistics (**page 77**).

\bar{x}_w Computes weighted average of *y-(item)* and *x-(weight)* values using accumulated statistics (**page 81**).

s Computes sample standard deviations of *x-* and *y-values* using accumulated statistics (**page 79**).

\hat{y}, r Linear estimate (X-register), correlation coefficient (Y-register). Fits a line to a set of (*x, y*) data pairs entered using $\Sigma+$, then extrapolates this line to estimate a *y-value* for a given *x-value*. Also computes strength of linear relationship (*r*) among that set of (*x, y*) data pairs (**page 80**).

\hat{x}, r Linear estimate (X-register), correlation coefficient (Y-register). Fits a line to a set of (*x, y*) data pairs entered using $\Sigma+$, then extra-polates this line to estimate an *x-value* for a given *y-value*. Also computes strength of linear relationship (*r*) among that set of (*x, y*) data pairs (**page 80**).

Mathematics

\sqrt{x} Computes square root of number in displayed X-register (**page 83**).

y^{x^y} Raises number in Y-register to power of number in X-register (**page 85**).

$1/x$ Computes reciprocal of number in displayed X-register (**page 83**).

$n!$ Computes factorial [$n \cdot (n-1) \dots 3 \cdot 2 \cdot 1$] of number in displayed X-register (**page 83**).

e^x Natural antilogarithm. Raises *e* (approximately 2.718281828) to power of number in displayed X-register (**page 83**).

\ln Computes natural logarithm (base *e*) of number in displayed X-register (**page 83**).

Number Alteration

RND Rounds mantissa of 10digit number in X-register to match the display (**page 83**).

INTG Leaves only the integer portion of number in displayed X-register by truncating fractional portion (**page 83**).

FRAC Leaves only the fractional portion of number in displayed X-register by truncating integer portion (**page 84**).

Stack Rearrangement

$X \leftrightarrow Y$ Exchanges contents of X and Y-registers of stack (**pages 74 and 172**).

$\text{R}\downarrow$ Rolls down contents of stack for viewing in displayed X-register (**page 172**).

LSTx Recalls number displayed before the previous operation back into the displayed X-register (**pages 74 and 176**).

Programming Key Index

P/R Program/Run. Toggles into and out of Program mode. Automatically sets program to line 00 when returning to Run mode (**page 86**).

MEM Memory map. Describes the current allocation of memory; the number of lines allotted to program memory and the number of available data registers (**page 93**).

Program Mode	Run Mode	
<p>In <i>Program</i> mode, function keys are recorded in program memory. Display shows program memory line number and the keycode (keyboard row and location in row) of the function key.</p>	<p>In <i>Run</i> mode, function keys may be executed as part of a recorded program or individually by pressing from the keyboard.</p>	
<p>Active Keys: In Program mode only the following keys are active; they cannot be recorded in program memory.</p> <p>CLEAR_{PRGM} Clear program. Clears program memory to all GTO00 instructions and resets calculator so operations begin at line 00 of program memory. Resets MEM to P08 r20 (page 95)</p>	<p>Pressed from keyboard:</p> <p>CLEAR_{PRGM} Resets calculator (in Run mode) so operations begin at line 00 of program memory. Does not erase program memory.</p>	<p>Executed as a recorded program instruction</p>

Program Mode	Run Mode	
<p>Active Keys:</p> <p>[GTO] Go to. Followed by a decimal point and a two-digit number, positions calculator to that line in program memory. No instructions are executed (page 95)</p> <p>[SST] Single step. Displays line number and contents of next program memory line. If held down, displays line number and contents of all program memory lines, one at a time (page 92).</p> <p>[BST] Back step. Displays line number and contents of previous program memory line. When back stepped from line 00, goes to end of program memory as defined by [9] MEM. If held down, displays line number and contents of all program memory lines, one at a time (page 95).</p>	<p>Pressed from keyboard:</p> <p>[R/S] Run/Stop. Begins execution of a stored program. Stops execution if program is running (page 89).</p> <p>[GTO] Go to. Followed by a two-digit number, positions calculator to that line in program memory. No instructions are executed (page 103).</p> <p>[SST] Single step. Displays line number and keycode of current program memory line when pressed; executes instruction, displays result, and moves to next line when released (page 96).</p> <p>[BST] Back step. Displays line number and keycode of previous program memory line when pressed; displays original contents of X-register when released. No instructions are executed (page 97).</p> <p>Any key. Pressing any key on the keyboard stops execution of a program (page 102)</p>	<p>Executed as a recorded program instruction:</p> <p>[R/S] Run/Stop. Stops program execution (page 101).</p> <p>[GTO] Go to. Followed by a two-digit number, causes calculator to branch to the specified line number next, and resumes program execution from there (page 103).</p> <p>[PSE] Pause. Stops program execution for about 1 second and displays contents of X-register, then resumes program execution (page 97).</p> <p>[x≤y] [x=0] Conditional. [x≤y] tests number in X-register against that in Y-register. [x=0] tests number in X-register against zero. If true, calculator continues execution at next program memory line. If false, calculator skips next line before resuming execution (page 107)</p>

Subject Index

A

AMORT, 12, 54, 172
Adding instructions, 114–19
Advance payments, 151, 156
Amortization, 38, 54–56, 186
Annual interest rate, 39
Annual Percentage Rate, 52–53, 124–26, 202
Annuities, 36
Annuities, deferred, 134–35
Annuity due, 37–38
Appreciation, 38
APR. See Annual Percentage Rate
Arithmetic calculations with constants, 75, 177
Arithmetic calculations, chain, 20–22
Arithmetic calculations, simple, 19
Arithmetic operations and the stack, 173
Arithmetic, storage register, 24
Average. See Mean
Average See Mean, 77

B

BEG, 37
BST, 92
Backstep, 92
Balloon payments, 40, 41
Battery, 193
Battery power, low, 12, 16, 193
Battery, installing, 193–94
BEGIN status indicator, 37
Bonds, 66–68, 163–67, 188, 202
Bonds, 30/360 day basis, 163–65
Bonds, annual coupon, 166
Bonds, corporate, 67

Bonds, municipal, 67
Bonds, state and local government, 67
Bonds, U.S. Treasury, 66
Branching, 103–12, 116
Branching, adding instructions by, 116–19
Branching, conditional, 107–8
Branching, simple, 103

C

CFo, 61
CFI, 59, 61, 64
CHS, 17, 19, 33, 59
CLX, 18, 28
X.r, 172
Y.r, 172
C status indicator, 51
Calendar functions, 29–31, 187
Calendar functions and the stack, 175
Cash flow diagram, 34–38
Cash flow sign convention, 33, 36
Cash flows, changing, 65
Cash flows, reviewing, 64
Cash flows, storing for I and L, 58, 65
Chain calculations, 20–22, 176–77
Clearing display, 18
Clearing financial registers, 18
Clearing operations, 17, 18
Clearing prefix keys, 17
Clearing program memory, 18, 89
Clearing statistics registers, 18, 76
Clearing storage registers, 18, 24, 70
Clearing X-register, 18
Compound growth, 37, 39

Compound interest, 39–53, 186
 Compound interest calculation, 11
 Compounding periods, 34, 39
 Conditional branching, 107–8
 Conditional test instructions, 107
 Constants, arithmetic calculations
 with, 177
 Constants, arithmetic calculations
 with, 75
 Continuous compounding, 162, 191
 Continuous effective rate, 162
 Continuous memory, 70
 Continuous memory, resetting of, 33,
 37, 70, 72, 93, 94

D

DATE, 29–31
DB, 68, 172
ADYS, 51, 172
 D.MY status indicator, 30
 Data storage registers, 23–25
 Date format, 29, 70
 Dates, days between, 31
 Dates, future or past, 30
 Days, between dates, 31
 Decimal places, rounding, 71
 Decimal point, changing, 17
 Declining-balance depreciation, 139
 Deferred annuities, 134–35
 Depreciation, 68, 136–48, 189–90
 Depreciation, declining-balance,
 139
 Depreciation, excess, 148
 Depreciation, partial year, 136–48
 Depreciation, sum-of-the-years-digits,
 141
 Depreciation, with crossover,
 144–48
 Digit entry, recovering from errors in,
 75
 Digit entry, termination of, 19, 171
 Discounted cashflow analysis, 57
 Display, 71

Display format, mantissa, 73
 Display format, standard, 71
 Display formats, number, 71
 Display, scientific notation, 72
 Displaying numbers, 32
 Displays, special, 73

E

EEX, 18
 Editing a program, 113
 Effective interest rate, converting,
 161
 Entry errors, 75
 Error conditions, 74
 Error, Pr, 74
 Errors, 74
 Errors, in digit entry, 75
 Excess depreciation, 148
 Exponent, 18, 85
 Exponential, 83

F

Factorial, 83
 Financial registers, 32
 Financial registers, clearing, 33
 Fractional, 84
 Future value, 36
 Future value, calculating, 48
 FV, 36

G

GTO, 93

I

i, 12
INT, 172
IRR, 12
 Indicators, status, 71
 Instructions in program lines, 91
 Interest rate, annual, 43
 Interest rate, periodic, 43

210 Subject Index

Interest, simple, 33
Internal rate of return, 57
Internal rate of return, calculating, 63
Internal rate of return, modified, 148
Interrupting a program, 97
IRR, 57, 148

K

Keyboard, 16

L

$\boxed{\text{LSTx}}$, 74
LAST X register, 70
Leasing, 151
Linear estimation, 80
Logarithm, 83
Looping, 103
Low-power indicator, 16

M

$\boxed{\bar{x}}$, 172
Mantissa, 18, 73
Mantissa Display Format, 73
Mean, 77
Mean, weighted, 81
memory, 23
Memory, program, 94
Modified internal rate of return, 148
Mortgage, price of, 126
Mortgage, yield of, 128
Multiple programs, 120

N

Negative numbers, 17
Net amount, 27
Net present value, 57
Net present value, calculating, 58
Nominal interest rate, converting, 160
Nominal rate, 162
NPV, 57

Number display formats, 71
Numbers, keying in, 17
Numbers, large, 18
Numbers, negative, 17
Numbers, recalling, 23
Numbers, storing, 23

O

Odd-period calculations, 50
Odd-period mode, 36
One-number functions, 83
One-variable statistics, 76
Overflow, 73

P

$\boxed{\text{PSE}}$, 97
 $\boxed{\text{PRICE}}$, 172
Partial-year depreciation, 136
Payment, 36, 156
Payment amount, calculating, 46
Payment mode, 37
Payments, advance, 151, 156
Payments, number of, 39
Percent difference, 27
Percent of total, 28
Percentages, 26
PMT, 36
Populations, 79
Power function, 85
Pr error, 74
Prefix key, 16
Present value, 36
Present value, calculating, 44
PRGM status indicator, 88, 89
Program branching, 103
Program editing, 113
Program lines, displaying, 92
Program looping, 103
Program memory, 90, 94
Program mode, 88
Program, creating, 88
Program, interrupting, 97
Program, running, 89, 122

Program, running one line at a time, 94
 Program, stopping, 97, 101
 Program, storing, 120
 Programming, 88
 Programs, multiple, 120
 PV, 36

R

RND, 83
 Reciprocal, 83
 registers, 23
 Registers, financial, 32
 Registers, statistics, 76
 Renting versus Buying, 130
 Residual, 156
 Round, 83
 Rounding, 71
 Running message, 12, 63

S

S, 172
SL, 172
SOYD, 172
STO, 23
 Samples, 79
 Savings, 160
 Scientific notation, 18, 72
 Simple branching, 103
 Simple interest, 33

Square Root, 83
 Stack, 170
 Standard deviation, 79
 Statistics, 76
 Status indicators, 71
 Storage register arithmetic, 24
 Storage registers, clearing, 24
 Storing numbers, 32
 Storing programs, 120
 Straight-line depreciation, 136
 Sum-of-the-years-digits depreciation, 141

T

Two-variable statistics, 76

U

Underflow, 73

W

Weighted mean, 81

X

X \leftrightarrow Y, 74

Y

YTM, 12
 Yield, 154, 158